

**GEOTECHNICAL STUDY
PROPOSED DWELLING WITH ATTACHED GARAGE**

**ZAHEDI PROPERTY
12400 SKYLINE BOULEVARD
SAN MATEO COUNTY, CALIFORNIA**

Prepared For:

**Mr. Omid Zahedi
12400 Skyline Boulevard
Woodside, California**

27 May 2022
Document Id. 22033C-01R1

This document is protected under Federal Copyright Laws. Unauthorized use or copying of this document by anyone other than the client(s) is strictly prohibited. If use or copying is desired by anyone other than the client, complete the "APPLICATION TO USE" attached to this document and return it to C2Earth, Inc.



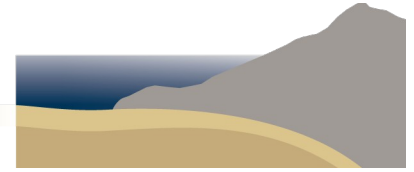

27 May 2022

Document Id. 22033C-01R1

Serial No. 19880

Mr. Omid Zahedi
12400 Skyline Boulevard
Woodside, CA 94062

SUBJECT: GEOTECHNICAL STUDY
PROPOSED DWELLING WITH ATTACHED GARAGE
ZAHEDI PROPERTY
12400 SKYLINE BOULEVARD
SAN MATEO COUNTY, CALIFORNIA

Dear Mr. Zahedi:

As requested, we have performed a geotechnical study for the design and construction of a new dwelling with an attached garage on your property at 12400 Skyline Boulevard in the Woodside area of unincorporated San Mateo County, California. The accompanying report presents the results of our study and testing, and our conclusions and recommendations concerning the geotechnical engineering aspects of the project. The findings and recommendations presented in this report are contingent upon our review of the final grading, foundation, and drainage control plans; our observation of the grading; and the installation of the foundation and drainage control systems.

This report includes information that is vital to the success of your project. We strongly urge you to thoroughly read and understand its contents. Please refer to the text of the report for detailed findings and recommendations.

Sincerely,
C2Earth, Inc.

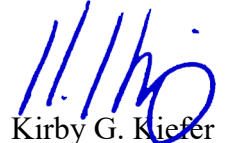
Kirby G. Kiefer
Project Geologist

THIS DOCUMENT HAS
BEEN DIGITALLY SIGNED

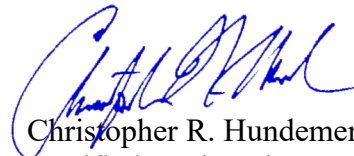
Christopher R. Hundemer, Principal
Certified Engineering Geologist 2314
Certified Hydrogeologist 882
Registered Civil Engineer 87149



Distribution: Addressee (1 hard copy via mail and via e-mail to omid@risepizzeria.com)
Mr. James Gwise (via e-mail to jgwise@jamesgwise.com)



TABLE OF CONTENTS

1. INTRODUCTION.....	2
2. SCOPE OF SERVICES.....	2
3. SITE CHARACTERIZATION.....	3
3.1. Regional Setting.....	3
3.2. Site Description.....	3
3.3. Subsurface.....	4
3.4. Groundwater.....	4
3.5. Laboratory Testing.....	4
4. FINDINGS.....	5
4.1. Proposed Building Site.....	5
4.2. Slope Stability.....	5
4.3. Seismicity.....	6
5. RECOMMENDATIONS.....	6
5.1. Location of Proposed Improvements.....	6
5.2. Seismic Design Criteria.....	6
5.3. Earthwork.....	7
5.4. Foundations.....	10
5.5. Drainage.....	17
6. PLAN REVIEW AND CONSTRUCTION OBSERVATION.....	18
BIBLIOGRAPHY	
LIST OF AERIAL PHOTOGRAPHS	
FIGURES	
APPENDIX: ASCE 7 HAZARDS REPORTS	
APPLICATION TO USE	



1. INTRODUCTION

This report presents the results of our geotechnical study for the design and construction of a proposed dwelling with an attached garage on your property at 12400 Skyline Boulevard in the Woodside area of unincorporated San Mateo County, California (see Figure 1, Site Location Map). The purpose of our study was to explore the geotechnical conditions on the subject property in the area of the proposed improvements and to develop findings and recommendations for the earthwork and foundation engineering aspects of the proposed development. Our study was limited to the general vicinity of the subject residence and associated improvements.

We understand that you are planning to construct a new, approximately 2,500 square-foot, multi-story dwelling in the southeast portion of your property. An attached garage will comprise a portion of the structure's lower level. The dwelling will be accessed by a new driveway alignment. Site grading and site retaining walls are planned as part of the project. We anticipate that the structure will be serviced by an existing, on-site wastewater treatment system (leachfield) located downslope and west of the building. We anticipate that an existing, smaller cottage structure, northeast of the proposed dwelling, will remain and be converted to use as an accessory dwelling.

We issue this report with the understanding that it is the responsibility of the owner or the owner's representative to ensure that the information and recommendations contained in this report are brought to the attention of the project architect and engineer and are incorporated into the plans and specifications of the development. You must also ensure that the contractor and sub-contractors follow the recommendations during construction.

2. SCOPE OF SERVICES

We conducted this study in accordance with the scope and conditions presented in our proposal dated 14 March 2022 (Document Id. 22033C-01P1). The methodology of our evaluation is discussed in the body of this report. We make no other warranty, either expressed or implied. Our scope of services for this study included:

- Reviewing selected geologic literature, aerial photographs, and previous consultants' reports of the area, to evaluate the prevailing geotechnical conditions;
- performing an engineering reconnaissance and mapping of the site in the area of the proposed improvements;
- preparing a partial site plan and slope profiles;
- conducting subsurface exploration;
- performing field and laboratory testing;
- analyzing geotechnical engineering properties from collected data; and
- preparing this report.

We have prepared this report as a product of our service for your exclusive use in designing and constructing the proposed improvements. Other parties may not use this report, nor may the report be used for other purposes, without prior written authorization from C2Earth, Inc (C2).



Because of possible future changes in site conditions or the standards of practice for geotechnical engineering, the findings and recommendations of this report may not be considered valid beyond three years from the report date, without review by C2. In addition, in the event that any changes in the nature or location of the proposed improvements are planned, the conclusions and recommendations of this report may not be considered valid unless we review such changes, and modify or affirm in writing the conclusions and recommendations presented in this report remain valid with respect to the changes.

A detailed evaluation of the engineering geologic site conditions or geologic hazards that could affect the property was beyond the scope of services performed as part of this study. In addition, our study excluded an evaluation of hazardous or toxic substances, corrosion potential, chemical properties, and other environmental assessments of the soil, subsurface water, surface water, and air on or around the subject property. The lack of comments in this report regarding the above does not indicate an absence of such associated hazards or risks.

3. SITE CHARACTERIZATION

3.1. Regional Setting

We reviewed the aerial photographs and topographic maps for the site and vicinity. The irregularly shaped, approximately 3.2-acre site is situated along the crest of the northwest-trending Skyline ridge. The northern portion of the property is bounded by private, developed properties. The remaining sides are bounded by Misty Ridge Road. The property is situated on a bedrock ridge. Based on our review, the site is not mapped within current State of California Seismic Hazard zones for earthquake fault rupture or earthquake-induced landsliding (see Figure 2, Regional Seismic Hazard Zones Map).

3.2. Site Description

On 26 April 2022, our principal geologist/engineer performed a site reconnaissance and marked the locations for our test borings on-site for utility clearance. On 2 May 2022, our project geologist visited the site to perform our subsurface exploration program and site mapping. The partial site plan we developed is based upon a topographic survey by BKF Engineers dated 24 March 2022, supplemented by tape and compass mapping techniques (see Figure 3, Partial Site Plan). We generated two slope profiles from topographic data on the survey and utilized the profiles to develop Cross-Sections A-A' and B-B', as depicted on Figure 4. The partial site plan and profiles are only as accurate as implied by the mapping techniques used. The following is a summary of the surficial site characteristics.

The proposed improvements are planned within the southeastern corner of the property. This area of the site is dominated by moderately-steep, approximately 3:1 (horizontal to vertical) or flatter slopes that descend to the southwest. The slope is mantled with grasses, and low brush. Temporary storage containers occupy a portion of the pad. Minor grading appears to have been performed to create a roughly level area where the containers sit. Misty Ridge Road continues around the southern portion of the site, south of the proposed dwelling area. Localized over-



steepened cut slopes are present along portions of the uphill side of the road, southwest of the proposed dwelling area. Drainage across this portion of the site is generally characterized as uncontrolled sheet flow to the southwest.

3.3. Subsurface

On 2 May 2022, our project geologist visited the site to observe the subsurface conditions at discrete locations in the vicinity of the proposed improvements. Our geologist logged three test borings, drilled to depths of approximately 16½ feet or less using a truck-mounted Mobile B-24 drilling rig. Samples were collected with conventional split-spoon samplers advanced using a rope and cathead driven 140-pound hammer.

The approximate locations of the test borings are shown on Figure 3. We determined these locations by measuring distance and bearing from known points on the supplied site plan; these locations are only as accurate as implied by the mapping technique used.

We logged the borings in general accordance with the Unified Soil Classification System and our Rock Classification System described on Figures 5 and 6, Key to Logs and Rock Classification System, respectively. A Summary of Field Sampling Procedures is presented on Figure 7. The boring logs are presented on Figures 8 through 10, Logs of Borings 1 through 3, respectively. The logs show our interpretation of the subsurface conditions at the locations and on the date indicated and we do not warrant that they are representative of the subsurface conditions at other locations and times.

In general, all three of the borings encountered a similar sequence of subsurface materials, including colluvium (a soil material that is deposited on or at the base of a slope from sheet flow runoff) underlain by sandstone bedrock.

The colluvium consists of medium stiff to stiff, very dark grayish brown to grayish brown sandy silt. The colluvium is approximately 4 feet thick or less and is underlain by weathered sandstone bedrock. The bedrock persisted to the bottom of all three borings. In general, the bedrock is comprised of moderate to deeply weathered, brownish yellow, medium to coarse-grained sandstone. Detailed descriptions of the subsurface materials encountered are presented on the boring logs.

3.4. Groundwater

We did not encounter groundwater in any of the borings. Fluctuations in the level of subsurface water could occur due to variations in rainfall, temperature, and other factors not evident at the time our observations were made.

3.5. Laboratory Testing

We developed our laboratory testing program to supplement our evaluation of the geotechnical engineering properties of the soil and bedrock at the site. We retained soil samples from the borings for laboratory classification and testing. The results of moisture content and dry density tests are presented on the logs.



4. FINDINGS

Based upon the results of our study, it is our opinion from a geotechnical engineering perspective that the proposed dwelling project may be developed as planned, provided that the recommendations presented in this report are incorporated into the design and construction of the proposed improvements. In our opinion, the primary constraints to the proposed development are: the moderately steep slopes around the proposed dwelling which are mantled by soil and colluvium; the potential for creep or shallow landsliding; and the site's seismic setting.

4.1. Proposed Building Site

Our subsurface study showed that the proposed dwelling site is underlain at depth by sandstone bedrock. The supportive bedrock is blanketed by about 4 feet or less of non-supportive colluvium. Where located on moderate to steep slopes, this non-supportive material can experience imperceptibly slow downhill creep under the force of gravity. In our opinion, the sandstone bedrock should provide adequate support for the foundations of the proposed dwelling and associated improvements.

Standard penetration test results suggest that the sandstone at the site has variable consistency and can be very hard locally. We recommend that a high-powered, well-maintained drill rig equipped with rock teeth be used to drill the pier excavations. The contractor should plan for this condition in choosing the appropriate means and methods of drilling.

4.2. Slope Stability

Our study showed no evidence of recent landsliding on the property in the vicinity of the proposed dwelling. However, because of the moderately steep slopes in the area of the proposed structure that are mantled by up to about 4 feet of colluvium, the occurrence of a new shallow landslide within or adjacent to the subject property cannot be excluded. A new shallow landslide (approximately less than 5 feet deep) in this area could be triggered by excessive precipitation or strong ground shaking associated with an earthquake. In our opinion, a landslide of this nature should not constitute an immediate threat to the integrity of the proposed dwelling and associated improvements, provided that they are designed and constructed in accordance with the recommendations of this report. Based upon our observations of the subsurface conditions and geologic setting of the site vicinity, it is our opinion that the potential for deep-seated landsliding that could affect the dwelling is negligible.

The long-term stability of many hillside areas is difficult to predict. A hillside will remain stable only as long as the existing slope equilibrium is not disturbed by natural processes or by the acts of Man. Landslides can be activated by a number of natural processes, such as the loss of support at the bottom of a slope by stream erosion or the reduction of soil strength by an increase in groundwater level from excessive precipitation. Artificial processes caused by Man include improper grading activities, the introduction of excess water through excessive irrigation, improperly designed or constructed leachfields, and poorly controlled surface runoff.



Although our knowledge of the causes and mechanisms of landslides has greatly increased in recent years, it is not yet possible to predict with certainty exactly when and where all landslides will occur. At some time over the span of thousands of years, most hillsides will experience landslide movement as mountains are reduced to plains. Therefore, a small but unknown level of risk is always present to structures located in hilly terrain. Owners of property located in these areas must be aware of, and willing to accept, this unknown level of risk.

4.3. Seismicity

Given the regional seismic setting, it is reasonable to assume that the site will be subjected to violent ground shaking from a major earthquake on at least one of the nearby active faults during the design life of future improvements (Association of Bay Area Governments, 2021). Improvements designed and constructed in accordance with the following recommendations and current building standards should maintain their structural integrity during the design level earthquake. It should be noted that following a large seismic event, cosmetic damage or sympathetic movement caused by ground shaking may occur and may have to be repaired.

5. RECOMMENDATIONS

Because the proposed project is still in a relatively early phase of development, it is conceivable that changes and additions will be made to the proposed improvement/development concept following submission of this report. We recommend that as various changes and additions are made, you contact us to evaluate the geotechnical aspects of these modifications.

As currently planned, a new multi-level dwelling will be constructed within a moderately steep sloping area south of the current cottage building on the site. The building will be partially set into the hillside, utilizing retaining walls on its northern and eastern sides. The southern portion of the lower level will be comprised of an attached garage. The structure will be accessed by a new graded driveway that will lead from Misty Ridge Road to the garage. Site grading and retaining walls are anticipated to facilitate the proposed driveway alignment. The following recommendations must be incorporated into all aspects of future development.

5.1. Location of Proposed Improvements

The proposed improvements must be confined to the approximate building area shown on Figure 3. Do not construct improvements outside of this generalized area without written approval from C2. If other structures are planned in the future, we must evaluate their location to provide appropriate geotechnical engineering design criteria.

5.2. Seismic Design Criteria

We recommend that the project structural design engineer provide appropriate seismic design criteria for proposed foundations and associated improvements. The following information is intended to aid the project structural design engineer to this end and is based on criteria set forth in the 2019 California Building Code (CBC). The mapped spectral accelerations and site coefficients have been computed using the ASCE/SEI 7-16 and 7-22 design standards, and the



ASCE 7-16 and 7-22 Hazard Reports are presented in the Appendix of this report. The structural designer should select the applicable standard for use, and confirm the Seismic Risk Category, and make revisions as they deem appropriate.

Experience has shown that earthquake-related distress to structures can be substantially mitigated by quality construction. We recommend that a qualified and reputable contractor and skilled craftsmen build the associated improvements. We also recommend that the project structural design engineer and project architect monitor the construction to make sure that their designs and recommendations are properly interpreted and constructed.

5.3. Earthwork

At the time of this study, the full extent of any proposed earthwork had not been finalized. We anticipate that a moderate amount of grading will be required to construct the proposed improvements and will consist of: grading for the driveway, excavations for the building pad, excavating and backfilling utility trenches, and preparations of subgrade areas for flatwork. Any proposed earthwork should be performed in accordance with the recommendations provided below.

5.3.1. Clearing and Site Preparation

- Clear all obstructions, including brush, trees not designated to remain, and debris on any areas to be graded.
- Clear and backfill any holes or depressions resulting from the removal of underground obstructions below proposed finished subgrade levels with suitable material compacted to the requirements for engineered fill given below.
- After clearing, strip the site to a sufficient depth to remove all surface vegetation and organic-laden topsoil. At the time of our field study, we estimated that a stripping depth of approximately 3 inches would be required on natural slope areas. This material must not be used as engineered fill; however, it may be used for landscaping purposes.

5.3.2. Fill Material

Based on our study, it is our opinion that the materials encountered in the borings should be suitable for use as fill. On-site or imported materials must meet the requirements specified below to be used as engineered fill:

- Materials used for engineered fill must meet the following requirements:
 - 1) Have an organic content less than 3% by volume;
 - 2) no rocks or lumps greater than 6 inches in maximum dimension;
 - 3) no more than 15% of the fill may be greater than 2½ inches in maximum dimension; and
 - 4) have a plasticity index (PI) of 15 or less.



- If on-site materials do not meet the requirements given above, they may be off-hauled or used for landscaping purposes only.
- **Contact C2 with samples of proposed fill materials at least four days prior to fill placement for laboratory testing and evaluation.**

5.3.3. Keyways and Benches

- Unretained fill placed on slopes in excess of 5:1 must be keyed and benched into the underlying supportive bedrock to provide a firm, stable surface for support of the fill.
- A keyway, located at the toe of proposed fill, must be excavated a minimum of 3 feet into the supportive bedrock, as measured on the downhill side of the keyway.
- Keyways and benches generally must be a minimum of 8 feet wide and must be excavated entirely into the supportive material.
- Temporary back slopes may be vertically excavated provided they are constructed in the dry season and meet Cal OSHA requirements.
- Both the keyway and any required benches must be excavated near level in the direction parallel to the natural slope and must be provided with an approximately 2% gradient sloping into the hillside to provide resistance to lateral movement and to facilitate proper subdrainage.
- **Contact C2 to evaluate the actual location, size, and depth of the required keyway and benches at the time of construction.**

5.3.4. Subdrains

- C2 must determine the need for subdrains at the time of construction.
- In general, fill exceeding 5 feet deep should be provided with subdrains.
- Subdrains must consist of a 4-inch diameter, rigid, heavy-duty, perforated pipe (Schedule 40 or equivalent), approved by C2, embedded in drainrock (crushed rock or gravel).
- Flexible corrugated pipe must not be used.
- The pipe must be placed with the perforations down on a 2- to 3-inch bed of drainrock. The drainrock must be separated from the fill and the native material by a geotextile filter fabric, approved by C2 (see Figure 11, Conceptual Engineered Fill Subdrain Diagram).
- Subdrain pipes must be provided with cleanout risers at their up-gradient ends and at all sharp changes in direction.



- Changes in pipe direction must be made with "sweep" elbows to facilitate future inspection and cleanout.
- Subdrain systems must be provided with a minimum 1% gradient and must discharge onto an energy dissipater at an appropriate downhill location approved by C2.

5.3.5. Compaction Procedures

- Prior to fill placement, scarify the surface to receive the fill to a depth of 6 inches.
- Moisture condition the imported fill to the materials' approximate optimum moisture content.
- Spread and compact the fill in lifts not exceeding 8 inches in loose thickness.
- Compact the fill to at least 90% relative compaction by the Modified Proctor Test method, in general accordance with the ASTM Test Designation D1557 (latest revision).
- **Contact C2 to observe the placement and test the compaction of engineered fill.** Provide at least two working days notice prior to placing fill.

5.3.6. Permanent Slopes

- Construct the gradients of permanent cut or fill slopes no steeper than 2:1.
- Re-vegetate all graded surfaces or areas of disturbed ground prior to the onset of the rainy season following construction to control soil erosion.
- Install other erosion control provisions if vegetation is not established by the rainy season.
- Maintain ground cover vegetation once it is established to provide long-term erosion control.

5.3.7. Trench Backfill

- Backfill all utility trenches with compacted engineered fill.
- Place suitable on-site soil into the trenches in lifts not exceeding 8 inches in uncompacted thickness, and compact it to at least 90% relative compaction by mechanical means only.
- If imported sand is used, compact it to at least 90% relative compaction. Do not use water jetting to obtain the minimum degree of compaction in imported sand backfill. If the trench is greater than 50 feet long, located on sloping ground greater than 5:1 (horizontal to vertical), and is backfilled with sand, check dams should be installed to reduce the potential of the sand washing out.
- Compact the upper 6 inches of trench backfill to at least 95% relative compaction in all pavement areas.
- **Contact C2 to observe and test compaction of the fill.**



5.3.8. Temporary Excavations

- Perform temporary excavations using an OSHA approved benching or sloping cut configuration selected by an OSHA “Competent Person”. The Competent Person must be capable of identifying hazards during construction, such as slope instability, and take prompt corrective measures to mitigate any potential hazard.
- To aid the Competent Person in their selection of construction means and methods, consider the on-site soil and upper portion of the bedrock to be an OSHA Soil Type B. The Competent Person must evaluate the excavation during construction and confirm the suggested OSHA soil classification type.
- As an alternative to benching and sloping, shoring may be used to support temporary cuts. Consult with a shoring specialist for the design and installation of temporary shoring.
- We recommend documenting the condition of the adjacent roadway and any other nearby facilities prior to excavating and/or installing shoring.
- The contractor is solely responsible for means and methods of construction and should designate appropriate personnel to act as the Competent Person.
- **Contact C2 to observe the subsurface conditions** exposed within the excavations to assess whether they are consistent with expected subsurface conditions.

5.4. Foundations

Because the proposed building site is underlain by up to about 4 feet of non-supportive colluvium, and because one or more portions of the proposed garage floor may be at an elevation above current site grades and require fill, we recommend the dwelling be supported on drilled, cast-in-place, straight-shaft concrete friction piers gaining support in the underlying bedrock. The garage slab should be designed and constructed as a structural slab supported by piers. Site retaining walls may be designed and constructed as soldier-beam and lagging walls, poured concrete walls supported by drilled piers, or as flexible, segmental retaining walls.

We recommend that your engineer design and your contractor construct the proposed foundation elements in accordance with the following recommendations.

5.4.1. Drilled Piers

- Drill piers with a minimum diameter of 16 inches and embed them a minimum of 8 feet or the depth of overburden (which ever is greater) into the underlying bedrock below the plane at which there is a minimum of 5 feet horizontal separation between the downhill face of the pier and the surface of the bedrock.
- Design and construct drilled piers no closer than 3 pier diameters apart (measured center of pier to center of pier).

- Neglect the upper 2 feet of bedrock for lateral support and consider active and passive pressure loading to be negligible within the upper 2 feet of the bedrock (to achieve the recommended 5 feet of horizontal separation between the downhill face of the pier and the surface of the bedrock).
- Total pier depth will vary across the building site depending on the depth of the non-supportive soil and the extent of prior grading.
- Design the portion of the piers in the bedrock using a skin friction value of 500 psf for dead plus live loads, with a 1/3 increase for transient loads, including wind and seismic.
- Neglect any portion of the piers in fill and non-supportive colluvium and any point-bearing resistance for support.
- Figure active loads on the upper portion of the piers in the colluvium (and in any future fill around the garage area) on the basis of an equivalent fluid weight of 45 pcf taken over **2 times** the pier diameter. The depth of the active loads will vary across the building site depending on the depth of prior grading. Where the colluvium is removed by grading, active loads will be negligible. Where proposed structures are built at existing grades, active loads may extend to depths of approximately 4 feet. To facilitate construction, it may be appropriate for the structural engineer to prepare a table that provides pier depths and design based on various wall heights and an active zone that could vary from 0 to 6 feet.
- Design for resistance to lateral loads using a passive pressure equal to an equivalent fluid weight of 450 pcf to a maximum of 4,000 psf taken over **1½ times** the pier diameter for the length of the piers in the bedrock below the plane at which there is a minimum of 5 feet horizontal separation between the downhill face of the pier and the surface of the bedrock (see Figure 12, Conceptual Pier Pressure Diagram).
- Anticipate differential and total settlement for piers founded in supportive material to be less than 1 inch.
- Because the bedrock has variable consistency and can be locally very hard, it may be difficult to drill. The contractor should plan for this conditions and choose the appropriate means and methods of drilling.
- Clear the bottoms of the pier excavations of loose cuttings and soil fall-in prior to the installation of the reinforcing steel and the placement of concrete.
- Remove any accumulated water in the excavations prior to the placement of the steel and concrete.
- Reinforce the piers with a full-length cage containing a minimum of four No. 5 steel reinforcing bars.

- The structural engineer must determine the actual number, size, location, depth, spacing, and reinforcement of the piers, based on the anticipated building loads and the soil engineering design parameters provided above.
- **Contact C2 to observe the piers as they are being drilled** to assess whether the piers are founded in material of sufficient supporting capacity.

5.4.2. Grade Beams

- Design any grade beam retaining more than 2 feet of soil for an active pressure of 45 pcf.
- Reinforce grade beams with top and bottom reinforcement to provide structural continuity and to permit the spanning of local irregularities.
- Provide good structural continuity between the grade beam and the piers.
- The structural design engineer must determine the actual size and reinforcement of the grade beams.
- Remove any concrete overpour before the concrete has achieved its design strength.

5.4.3. Retaining Walls

We anticipate that retaining walls will be used on the site. The following recommendations are for cantilever type walls. Contact us to provide appropriate recommendations if you consider other types of walls.

- Support retaining walls that are part of the structure, poured concrete site retaining walls, and soldier-beam and wood lagging retaining walls on drilled pier foundations designed in accordance with the recommendations given above for the support of the proposed residence.
- Design retaining walls to resist both lateral earth pressures and any additional lateral loads caused by surcharge loads on the adjoining ground surface.
- Deflection of cantilever retaining walls will occur in response to lateral loading. Anticipate horizontal deflections at the top of the wall to be 2% of the wall height or less.
- Design unrestrained (active condition) walls to resist an equivalent fluid pressure of 45 pcf. Design walls that are restrained from movement at the top or sides (at-rest condition) to resist an equivalent fluid pressure of 67 pcf (see Figure 13, Conceptual Retaining Wall Pressure Diagram).

- Add an additional equivalent fluid pressure increment to the active and at-rest condition for backfill steeper than 4:1 (horizontal to vertical), in accordance with the following:
 - + 8 pcf for slopes between 3:1 and 4:1
 - + 12 pcf for slopes between 2:1 and 3:1
 - + Contact us for slopes steeper than 2:1
- Design for seismic-loading as the structural engineer deems appropriate. In our opinion, the requirements for seismic design of retaining walls are not clearly defined. Site walls are not subject to additional earthquake loading requirements.
- If the structural engineer considers seismic loading, based upon the procedures presented by Sitar, et. al. (2012), design unrestrained (active condition) residential retaining walls to resist an additional earthquake equivalent fluid pressure (seismic increment) of 41 pcf. If seismic loading is considered, design building retaining walls to resist the appropriate loading condition: either the at-rest condition if the walls are restrained, or the active condition plus the seismic increment if the walls are unrestrained.
- Wherever the walls will be subjected to surcharge loads, they must be designed for an additional uniform lateral pressure equal to 1/2 or 1/3 the anticipated surcharge load for restrained or unrestrained walls, respectively.
- The preceding pressures require that sufficient drainage be provided behind the walls to prevent the buildup of hydrostatic pressures from surface or subsurface water infiltration.
- Provide a backdrain system consisting of an approximately 1 foot thick curtain of drainrock (crushed rock or gravel) behind the wall.
- Separate the drainrock from the backfill by a geotextile filter fabric, such as Mirafi 140 or an alternative, approved by C2.
- For poured concrete walls, a 4-inch diameter heavy-duty rigid perforated subdrain pipe (Schedule 40 or equivalent), approved by C2, must be placed with the perforations down on a 2- to 3-inch layer of drainrock at the base of the drain. **Do not use flexible corrugated pipe.** As an alternative, backdrainage may consist of an approved drainage mat placed directly against the wall. The bottom of the drainage mat must be in contact with the rigid 4-inch perforated drainpipe embedded in gravel. The gravel must be fully encased in filter fabric.
- For soldier-beam and lagging walls, provide ½-inch spacers between lagging boards to promote weeping and allow dissipation of hydrostatic pressure, and do not use a perforated collection pipe.
- The backdrains should extend up the height of the back of the retaining walls to within 1 foot of the height of the retained soil, and then be covered with a compacted clay soil cap.

- Details of backdrain options are presented on Figure 14, Conceptual Retaining Wall Backdrain Diagram.
- Perforated retaining wall subdrain pipes must be dedicated pipes and must not connect to the surface drain system. Install the subdrain pipes with a positive gradient of at least 1% and provide them with cleanout risers at their up-gradient ends and at all sharp changes in direction. Changes in pipe direction must be made with "sweep" elbows to facilitate future inspection and cleanout. The perforated pipes must be connected to buried solid pipes to convey collected runoff to discharge onto an energy dissipater at an appropriate downhill location, approved by C2.
- Compact the backfill placed behind the walls to at least 90% relative compaction, using light compaction equipment, in accordance with the compaction procedures given above. If heavy compaction equipment is used, the walls should be appropriately temporarily braced, as the situation requires. If backfill consists entirely of drainrock, it should be placed in approximately 2-foot lifts and must be compacted with several passes of a vibratory plate compactor.
- Perform annual maintenance of retaining wall backdrain systems, which must include inspection and flushing to make sure that subdrain pipes are free of debris and are in good working order. This maintenance must also include inspection of subdrain outfall locations to verify that introduced water flows freely through the discharge pipes and that no excessive erosion has occurred.
- If erosion is detected, C2 must be contacted to evaluate its extent and to provide mitigation recommendations, if needed.
- Damp proof retaining walls that are adjacent to living spaces and/or site walls with decorative facing. We are not qualified to recommend specific damp proofing materials or their applications. Any damp proofing product must be applied in **strict** compliance with the manufacturer's and/or architect's specifications.
- If you select an alternative retaining wall type, you should contact C2 to provide additional recommendations.

5.4.4. Segmental Block Retaining Walls

- We recommend that the SRWs be designed and constructed in general accordance with the manufacturer's recommendations, including being provided with geogrid reinforcement, if necessary.
- The following material parameters may be used for the SRW design. For the underlying sandstone bedrock (foundation materials), use a unit weight of 127 pcf, an internal angle of friction of 32 degrees, and negligible cohesion with an allowable bearing capacity of 2,000 psf. For on-site colluvium and for engineered backfill derived from onsite materials (retained soils), use a unit weight of 116 pcf, an internal angle of friction of 25 degrees, and negligible cohesion. Flexible site walls are not subject to additional earthquake loading requirements.



- Construct the SRWs so that a minimum of one layer of blocks is keyed into the bedrock below any fill or colluvium.
- Calculate the wall height from the bottom of the lowest block to the top of the upper block.
- Apply appropriate surcharge loading for sloping ground at the top of the retaining wall in accordance with the manufacturer's recommendations.
- **Contact C2 to observe the excavation prior to placement of the SRW blocks** to evaluate if the blocks are founded in material of sufficient supporting capacity.
- **Contact C2 to observe the placement of geogrid and test the compaction of backfill.**
- Provide drainage provisions to prevent the build up of hydrostatic pressure in accordance with the manufacturer's recommendations.

5.4.5. Flatwork

We anticipate that a concrete slab-on-grade will be used for the garage floor, and other flatwork may be used for the driveway, patio, and walkways. Where located on colluvium and/or differential thicknesses of fill, the overlaying flatwork will be subject to downslope migration and differential movement. We believe this condition will result in minor ongoing cosmetic damage to the flatwork. To mitigate the risk of differential movement of the flatwork, we recommend the following options:

- Option 1: Construct flatwork using a flexible pavement system that can accommodate differential movement, such as pavers.
- Option 2: Construct flatwork areas on a uniform thickness of engineered fill that is keyed and benched into the supportive bedrock in accordance with the recommendation provided above.
- Option 3: Construct slabs as structural, pier-supported slabs.

For flexible pavement we recommend the following minimum requirements, which are based upon an anticipated Traffic Index (TI) of 3. If a greater TI is required for the project, contact C2 for appropriate recommendations.

- Scarify and re-compact the upper of 6 inches of the sub-base to the requirements for engineered fill given above.
- Use a minimum pavement section of 2 inches of asphalt over 6 inches of CalTrans Class II baserock compacted to at least 95% relative compaction in accordance with the requirements for engineered fill given above.
- **Contact C2 to observe and test compaction of the sub-base re-compaction and baserock compaction.**



For concrete flexible pavers we recommend the following minimum requirements:

- Support pavers on a minimum of 6 inches of non-expansive fill compacted to the requirements for compacted fill given above.
- Proof-roll the surface of the non-expansive fill to provide a smooth, firm surface, then place pavers on a leveling course per manufacturer's recommendations.
- Periodically repair cracked pavers or re-level pavers that experience differential movement.

For concrete slabs-on-grade we recommend the following minimum requirements:

- Support concrete slabs-on-grade on a minimum of 6 inches of non-expansive fill compacted to the requirements for compacted fill given above.
- Proof-roll the surface of the non-expansive fill to provide a smooth, firm surface for slab support prior to placement of reinforcing steel.
- Design slab reinforcement in accordance with anticipated use and loading, but at a minimum, reinforce slabs with No. 3 rebar on 18-inch centers each way, placed mid-height in the slab.
- Support the reinforcing steel from below on concrete blocks (or similar) during concrete pouring to make sure that it remains mid-height in the slab.
- Place grooves in the concrete slabs at 10-foot intervals or in accordance with the structural design engineer's recommendations to help control cracking.
- The structural designer must evaluate moisture conditions related to concrete slab curing and performance. The builder must provide appropriate drying time as determined by the designer.

Where floor wetness is undesirable:

The following recommendations are typical moisture barrier standards. We do not guarantee that these measures will prevent all future moisture intrusion. If necessary, you should consult a qualified waterproofing consultant to provide waterproofing design.

- The building designer or qualified waterproofing consultant must provide moisture barrier requirements.
- We recommend as a minimum using a puncture resistant, heavy-duty membrane (such as a minimum of 15 mil Stego Wrap, or equivalent) in direct contact with the floor slab and underlain by 6 inches of free-draining gravel.
- Use the gravel and heavy-duty membrane in lieu of the 6 inches of recommended non-expansive fill.



5.5. Drainage

Control of surface drainage is critical to the successful performance of the proposed improvements. The results of improperly controlled runoff may include foundation heave and/or settlement, erosion, gullying, ponding, and potential slope instability. To mitigate the risks associated with improperly controlled runoff, we recommend that you implement the following:

- Prevent surface water from ponding in areas adjacent to the foundation of the proposed dwelling and associated improvements by grading adjacent areas to create proper drainage by sloping them away from the structures.
- As an alternative, install area drains to collect surface runoff.
- Provide roof gutters with downspouts on the structure. Provide downspouts with slip-joint connectors or cleanouts, where they are connected to buried pipes, to facilitate maintenance (see Figure 15, Conceptual Downspout Cleanout Diagram).
- Do not allow water collected in the gutters to discharge freely onto the ground surface adjacent to the foundation.
- Convey water from downspouts and/or area drains away from the dwelling via buried, closed conduits or lined surfaces. Use buried conduits consisting of rigid, smooth-walled pipes (PVC). **Do not use flex-pipes.**
- Discharge collected water in an appropriate manner and at an appropriate location approved by C2.
- Energy dissipaters may consist of an approximately 6-foot long "T" fitting of perforated rigid pipe placed in a shallow bench and covered with a mound of cobbles (see Figure 16, Conceptual Energy Dissipater Diagram). The discharge must not be located on, or adjacent to, steep, potentially unstable terrain or where runoff will adversely impact adjacent parcels.
- Perform annual maintenance of the surface drainage systems, including:
 - 1) Inspecting and testing roof gutters and downspouts to make sure that they are in good working order and do not leak;
 - 2) inspecting and flushing area drains to make sure that they are free of debris and are in good working order; and
 - 3) inspecting surface drainage outfall locations to verify that introduced water flows freely through the discharge pipes and that no excessive erosion has occurred.
- Contact C2 if erosion is detected so that we may evaluate its extent and provide mitigation recommendations, if needed.



6. PLAN REVIEW AND CONSTRUCTION OBSERVATION

We must be retained to review the final grading, foundation, and drainage control plans in order to assess whether our recommendations have been properly incorporated into the proposed project. **WE MUST BE GIVEN AT LEAST TWO WEEKS TO REVIEW THE PLANS AND PREPARE A PLAN REVIEW LETTER.**

We must also be retained to observe the grading and the installation of foundations and drainage systems in order to:

- assess whether the actual soil conditions are similar to those encountered in our study;
- provide us with the opportunity to modify the foundation design, if variations in conditions are encountered; and
- observe whether the recommendations of our report are followed during construction.

Sufficient notification prior to the start of construction is essential, in order to allow for the scheduling of personnel to ensure proper monitoring.

WE MUST BE NOTIFIED AT LEAST TWO WEEKS PRIOR TO THE ANTICIPATED START-UP DATE. IN ADDITION, WE MUST BE GIVEN AT LEAST TWO WORKING DAYS NOTICE PRIOR TO THE START OF ANY ASPECTS OF CONSTRUCTION THAT WE MUST OBSERVE.

The phases of construction that we must observe include, but are not necessarily limited to, the following.

1. **EARTHWORK:** During construction to observe keyway and bench excavations, evaluate the need for subdrainage, and to test compaction of engineered fill
2. **DRILLED PIER EXCAVATION:** During drilling to evaluate depth to supportive material and final pier depths
3. **RETAINING WALL BACKDRAIN:** During installation
4. **RETAINING WALL BACKFILL:** During backfill to observe and test compaction
5. **SEGMENTAL BLOCK RETAINING WALL:** Prior to placement of the blocks to evaluate if the blocks are founded in material of sufficient supporting capacity and during placement of geogrid and/or fill
6. **FLATWORK AND FLEXIBLE PAVEMENT:** Prior to and during placement of non-expansive fill to observe the subgrade preparation and to test compaction of non-expansive fill
7. **SURFACE DRAINAGE SYSTEMS:** Near completion to evaluate installation and discharge locations

* * * * *

A Bibliography, a List of Aerial Photographs, and the following Figures and Appendix are attached and complete this report.

BIBLIOGRAPHY

AMERICAN SOCIETY OF CIVIL ENGINEERS, 2022, ASCE 7 Hazard Tool, available at www.asce7hazardtool.online.

AMERICAN SOCIETY OF CIVIL ENGINEERS, 2016, Minimum Design Loads and Associated Criteria for Buildings and Other Structures (ASCE/SEI 7-16).

AMERICAN SOCIETY OF CIVIL ENGINEERS, 2021, Minimum Design Loads and Associated Criteria for Buildings and Other Structures (ASCE/SEI 7-22).

ASSOCIATION OF BAY AREA GOVERNMENTS, 2021, Probabilistic Earthquake Shaking Hazard Assessment within the ABAG Hazard Viewer Map online tool located at <http://mtc.maps.arcgis.com/apps/webappviewer/index.html?id=4a6f3f1259df42eab29b35dfcd086fc8> (updated data set 31 March 2021).

CALIFORNIA BUILDING STANDARDS COMMISSION, 2019 California Building Code, California Code of Regulations, Title 24, Part 2, Volume 2 of 2.

CALIFORNIA GEOLOGICAL SURVEY, 2019, Earthquake Zones of Required Investigation, Woodside Quadrangle, Seismic Hazards Zones, Official Map Released: 4 April 2019, Earthquake Fault Zones, Official Map Released 1 July 1974.

HUNT, R.E., 2005, Geotechnical Engineering Investigation Handbook, CRC Press, Boca Raton, Florida.

SITAR, NICHOLAS, MIKOLA, ROOZBEH GERAILI, and CANDIA, GABRIEL, 2012, Seismically Induced Lateral Earth Pressures on Retaining Structures and Basement Walls, Geotechnical Engineering State of the Art and Practice, Keynote Lectures from GeoCongress 2012, Geotechnical Special Publication No. 226, ASCE

LIST OF AERIAL PHOTOGRAPHS

"BAY AREA TRANSPORTATION STUDY", black and white, dated May 16, 1965, at a scale of 1" = 1,000', Aerial Survey Contract No. 67615, Serial Nos. SM 10-88 and SM 10-89, State of California Highway Transportation Agency, Division of Highways.



FIGURES

FIGURE NO.

SITE LOCATION MAP.....	1
REGIONAL SEISMIC HAZARD ZONES MAP.....	2
PARTIAL SITE PLAN.....	3
CROSS-SECTIONS A-A' AND B-B'.....	4
KEY TO LOGS.....	5
ROCK CLASSIFICATION SYSTEM.....	6
SUMMARY OF FIELD SAMPLING PROCEDURES.....	7
LOGS OF BORINGS 1 THROUGH 3.....	8-10
CONCEPTUAL ENGINEERED FILL AND SUBDRAIN DIAGRAM.....	11
CONCEPTUAL PIER PRESSURE DIAGRAM.....	12
CONCEPTUAL RETAINING WALL PRESSURE DIAGRAM.....	13
CONCEPTUAL RETAINING WALL BACKDRAIN DIAGRAM.....	14
CONCEPTUAL DOWNSPOUT CLEANOUT DIAGRAM.....	15
CONCEPTUAL ENERGY DISSIPATER DIAGRAM.....	16

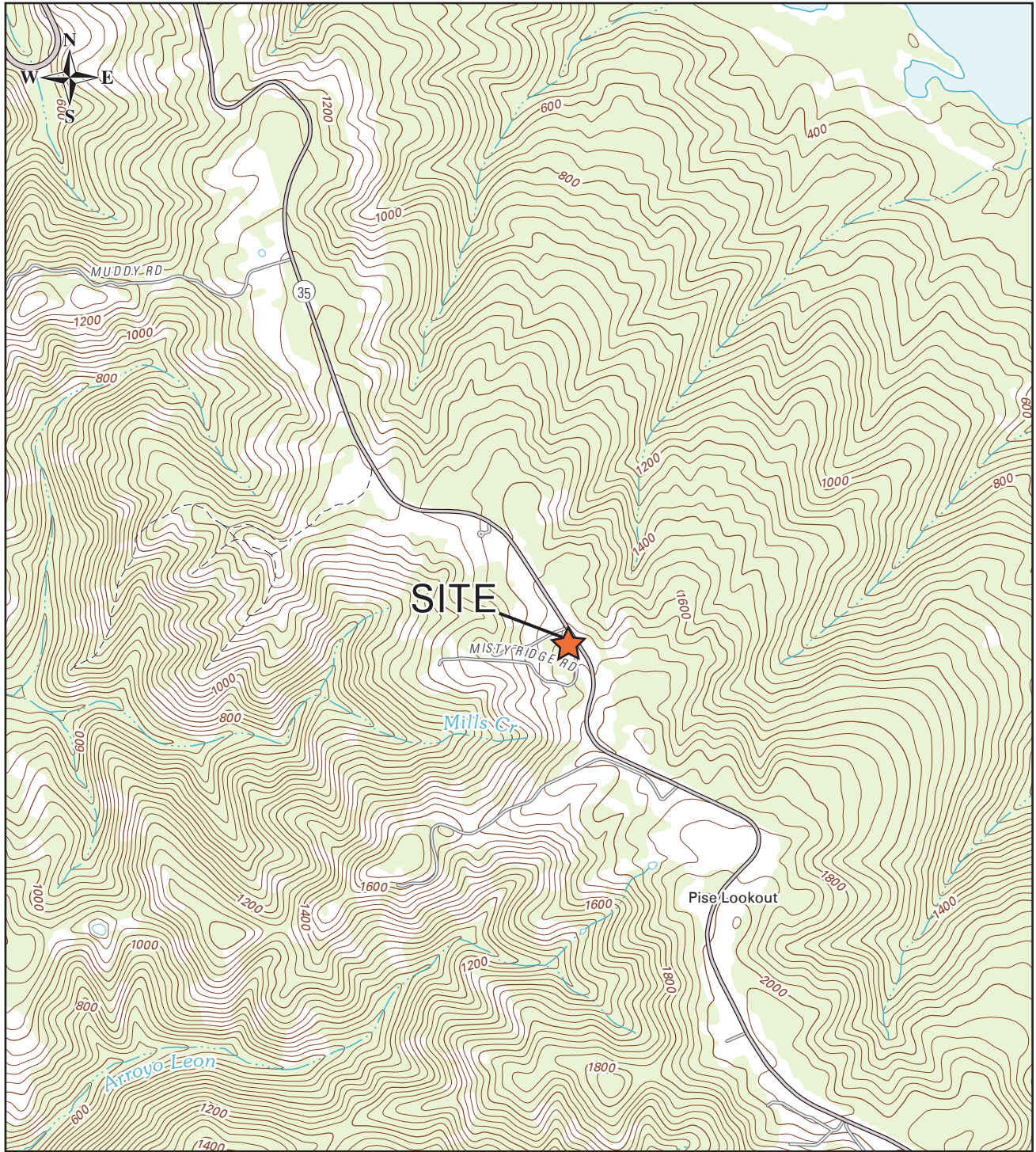

BASE: The National Map US Topo; UNITED STATES GEOLOGICAL SURVEY; 2012

SITE LOCATION MAP



ZAHEDI PROPERTY
 12400 Skyline Boulevard
 San Mateo County, California

DRAFTED/REVIEWED

SCALE

DOCUMENT ID.

DATE

MP/CH

1" = 2,000'

22033C-01R1

May 2022

Figure 1

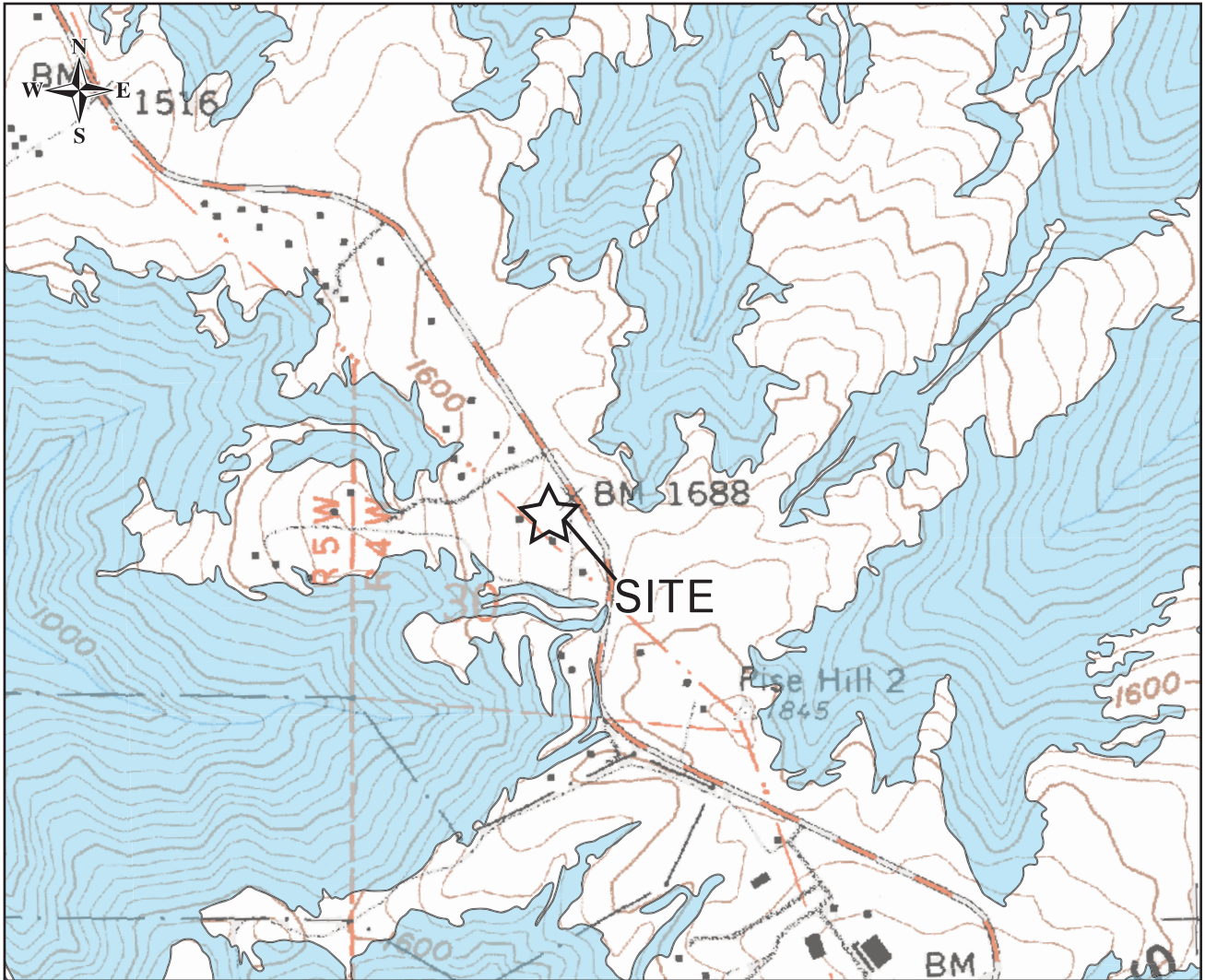

EXPLANATION



- **Earthquake-Induced Landslide Hazard Zones;** Areas where previous occurrence of landslide movement, or local topographic, geological, geotechnical, and subsurface water conditions indicate a potential for permanent ground displacements.

BASE: Earthquake Zones of Required Investigation, Woodside Quadrangle; California Geological Survey; 1 July 1974 and 4 April 2019

REGIONAL SEISMIC HAZARD ZONES MAP



ZAHEDI PROPERTY
 12400 Skyline Boulevard
 San Mateo County, California

DRAFTED/REVIEWED

SCALE

DOCUMENT ID.

DATE

MP/CH

1" = 1,000'

22033C-01R1

May 2022

Figure 2

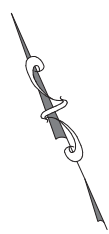

EXPLANATION	
	- Cut Slope
	- Test Boring Location and Number
	- Cross-Section Location
	- Proposed Dwelling with Attached Garage



PARTIAL SITE PLAN



ZAHEDI PROPERTY
 12400 Skyline Boulevard
 San Mateo County, California

BASE: Topographic Survey; Sheet C1.1; BKF ENGINEERS; 24 March 2022

DRAFTED/REVIEWED	SCALE	DOCUMENT ID.	DATE	Figure 3
KK/CH	AS SHOWN	22033C-01R1	May 2022	

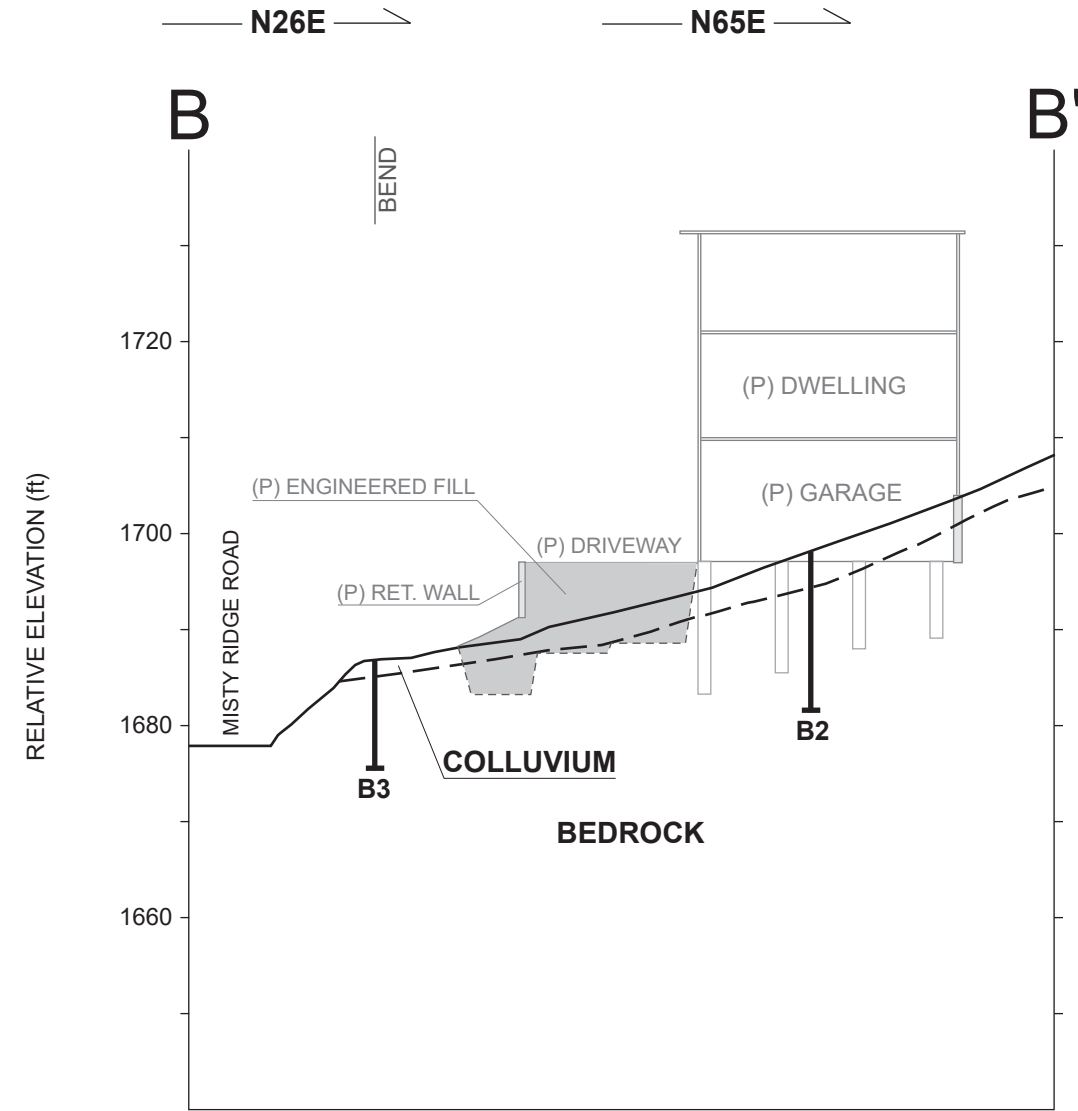
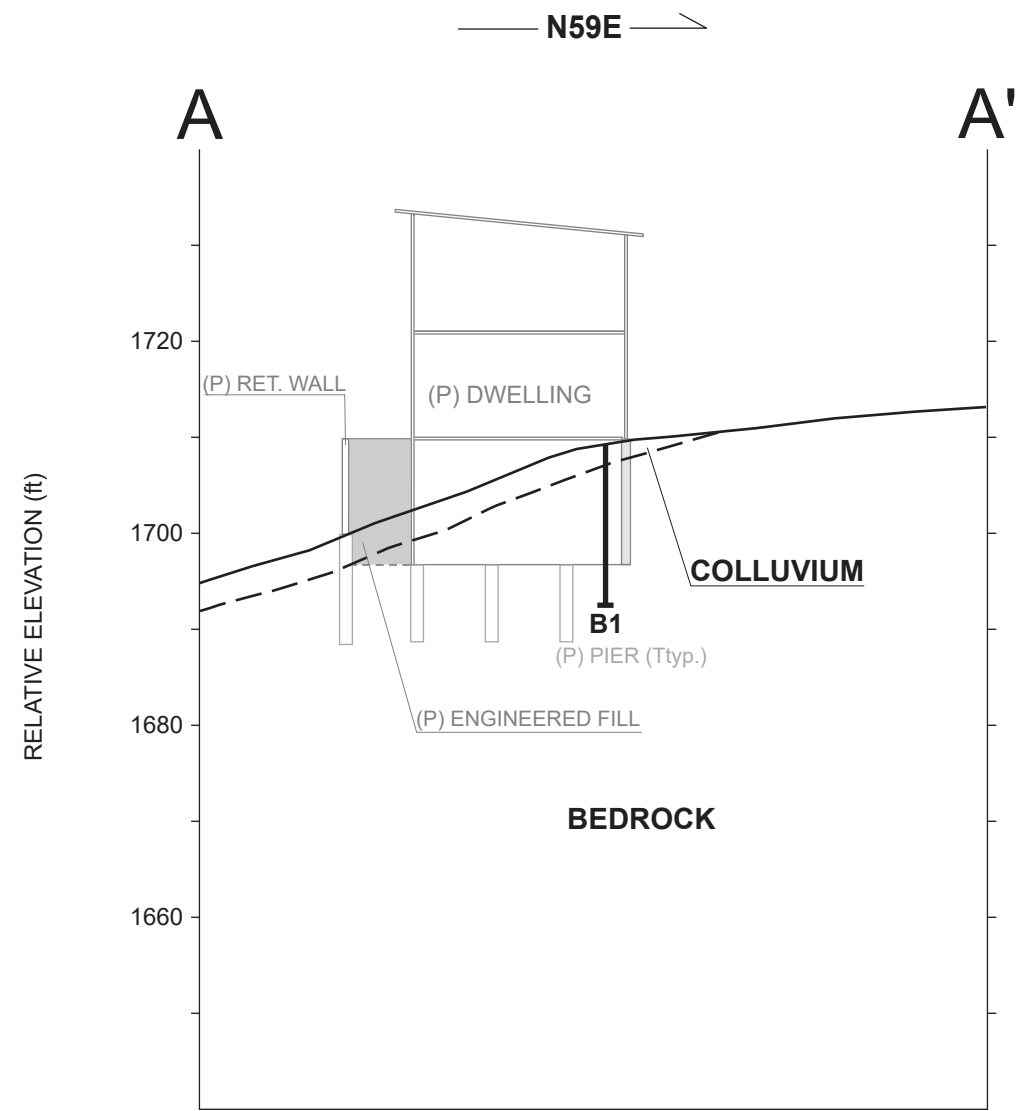

NOTE: This cross-section is a conceptual illustration of general subsurface relationships and should not be used for any other purpose.

BASE: Topographic Survey; Sheet C1.1 and Grading Plan; Sheet C2.1; BKF ENGINEERS; 24 March 2022

CROSS-SECTIONS A-A' AND B-B'					
		ZAHEDI PROPERTY 12400 Skyline Boulevard San Mateo County, California			
		DRAFTED/REVIEWED	SCALE	DOCUMENT ID.	DATE
KK/CH		1" = 20'	22033C-01R1	May 2022	Figure 4

UNIFIED SOIL CLASSIFICATION SYSTEM

PRIMARY DIVISIONS		GROUP SYMBOL	SECONDARY DIVISIONS		
COARSE GRAINED SOILS <small>MORE THAN HALF OF MATERIAL IS LARGER THAN NO. 200 SIEVE SIZE</small>	GRAVELS <small>MORE THAN HALF OF COARSE FRACTION IS LARGER THAN NO. 4 SIEVE</small>	CLEAN GRAVELS (LESS THAN 5% FINES)	GW	Well graded gravels; gravel-sand mixtures, little or no fines.	
		GRAVEL WITH FINES	GP	Poorly graded gravels or gravel-sand mixtures, little or no fines.	
		SANDS <small>MORE THAN HALF OF COARSE FRACTION IS SMALLER THAN NO. 4 SIEVE</small>	CLEAN SANDS (LESS THAN 5% FINES)	GM	Silty gravels, gravel-sand-silt mixtures, non-plastic fines.
			SANDS WITH FINES	GC	Clayey gravels, gravel-sand-clay mixtures, plastic fines.
	FINE GRAINED SOILS <small>MORE THAN HALF OF MATERIAL IS SMALLER THAN NO. 200 SIEVE SIZE</small>	SILTS AND CLAYS <small>LIQUID LIMIT IS LESS THAN 50%</small>	SW	ML	Inorganic silts and very fine sands, rock flour, silty or clayey fine sands or clayey silts with slight plasticity.
			SP	CL	Inorganic clays of low to medium plasticity, gravelly clays, sandy clays, silty clays, lean clays.
			SM	OL	Organic silts and organic silty clays of low plasticity.
		SILTS AND CLAYS <small>LIQUID LIMIT IS GREATER THAN 50%</small>	SC	MH	Inorganic silts, micaceous or diatomaceous fine sandy or silty soils, elastic silts.
SH			CH	Inorganic clays of high plasticity, fat clays.	
SH			OH	Organic clays of medium to high plasticity, organic silts.	
HIGHLY ORGANIC SOILS		Pt	Peat and other highly organic soils.		

GRAIN SIZES

U.S. STANDARD SERIES SIEVE	200	40	10	4	3/4"	3"	12"	SIEVE OPENINGS
SILTS AND CLAYS	SAND			GRAVEL		COBBLES	BOULDERS	
	FINE	MEDIUM	COARSE	FINE	COARSE			

CONSISTENCY AND RELATIVE DENSITY

CONSISTENCY	SILTS AND CLAYS	STRENGTH ²	BLOWS/FOOT ¹	RELATIVE DENSITY	SANDS AND GRAVELS	BLOWS/FOOT ¹
	VERY SOFT	0 - 1/4	0 - 2		0 - 2	VERY LOOSE
SOFT	1/4 - 1/2	2 - 4	2 - 4	LOOSE	4 - 10	
MEDIUM STIFF	1/2 - 1	4 - 8	4 - 8	MEDIUM DENSE	10 - 30	
STIFF	1 - 2	8 - 16	8 - 16	DENSE	30 - 50	
VERY STIFF	2 - 4	16 - 32	16 - 32	VERY DENSE	OVER 50	
HARD	OVER 4	OVER 4	OVER 32			

¹ Number of blows of 140-pound hammer falling 30 inches to drive a 2-inch O.D (1 3/8-inch I.D) split spoon

² Unconfined compressive strength in tons/sq. ft. as determined by laboratory testing or approximated in general conformance with the standard penetration test (ASTM D-1586), pocket penetrometer, torvane, or visual observation

KEY TO LOGS

	ZAHEDI PROPERTY 12400 Skyline Boulevard San Mateo County, California	
	DOCUMENT ID.	DATE
	22033C-01R1	May 2022
		Figure 5

FRACTURING

INTENSITY	SIZE OF PIECES (FEET)
VERY LITTLE FRACTURED	Greater than 4.0
OCCASIONALLY FRACTURED	1 - 4
MODERATELY FRACTURED	0.5 - 1
CLOSELY FRACTURED	0.1 - 0.5
INTENSELY FRACTURED	0.05 - 0.1
CRUSHED	Less than 0.05

HARDNESS

SOFT	Reserved for plastic material alone
LOW	Can be gouged deeply or carved easily with a knife blade
MODERATELY	Can be readily scratched by a knife blade; scratch leaves a heavy trace of dust and is readily visible after the powder has been blown away.
HARD	Can be scratched with difficulty; scratch produced a little powder and is often faintly visible.
VERY HARD	Cannot be scratched with knife blade; leaves a metallic streak.

STRENGTH

LOW	Plastic or very low strength.
FRIABLE	Crumbles easily by rubbing with fingers.
WEAK	An unfractured specimen of such material will crumble under light hammer blows.
MODERATELY	Specimen will withstand a few heavy hammer blows before breaking.
STRONG	Specimen will withstand a few heavy ringing hammer blows and will yield with difficulty only dust and small flying fragments.
VERY STRONG	Specimen will resist heavy ringing hammer blows and will yield with difficulty only dust and small flying fragments.

WEATHERING¹

DEEP	Moderate to complete mineral decomposition; extensive disintegration; deep and thorough discoloration; many fractures, all extensively coated or filled with oxides, carbonates and/or clay or silt.
MODERATE	Slight change or partial decomposition of minerals; little disintegration; cementation little to unaffected. Moderate to occasionally intense discoloration. Moderately coated fractures.
SLIGHT	No megascopic decomposition of minerals; little to no effect on normal cementation. Slight and intermittent, or localized discoloration. Few stains on fracture Surface.
FRESH	Unaffected by weathering agents. No disintegration or discoloration. Fractures usually less numerous than joints.

¹ The physical and chemical disintegration and decomposition of rocks and minerals by natural processes such as oxidation, reduction, hydration, solution, carbonation, and freezing and thawing.

BEDDING OF SEDIMENTARY ROCKS

SPLITTING PROPERTY	THICKNESS (FEET)
MASSIVE	Greater than 4.0
BLOCKY	2.0 - 4.0
SLABBY	0.2 - 2.0
FLAGGY	0.05 - 0.2
SHALY OR PLATY	0.01 - 0.05
PAPERY	Less than 0.01

STRATIFICATION	THICKNESS (FEET)
VERY THICK-BEDDED	Greater than 4.0
THICK-BEDDED	2.0 - 4.0
THIN-BEDDED	0.2 - 2.0
VERY THIN-BEDDED	0.05 - 0.2
LAMINATED	0.01 - 0.05
THINLY LAMINATED	Less than 0.01

ROCK CLASSIFICATION SYSTEM



ZAHEDI PROPERTY
12400 Skyline Boulevard
San Mateo County, California

DOCUMENT ID.

DATE

22033C-01R1

May 2022

Figure 6

The standard penetration resistance (SPT) blow counts are obtained in general accordance with ASTM Test Designation D1586. The drive weight assembly consists of a 70 or 140-pound hammer dropped through a 30-inch free fall. A blow count is defined as the number of hammer blows per six inches of penetration, or 50 blows for 6 inches or less of penetration. The driving of samplers was discontinued if the observed blow count was 50 for 6 inches or less of penetration.

SPT samples are collected in a standard, 2-inch outer diameter, split-barrel sampler without liners (see Figure A below). Samplers holding 2-inch diameter liners (see Figure B below) and 2½-inch diameter liners (see Figure C below) are used to obtain “undisturbed” samples. Occasionally a portable power driven sampler holding 1-inch diameter liners is used for field sampling (see Figure D below). Resistance is measured in seconds per foot and does not correlate with the ASTM SPT. Undisturbed samples may also be collected using a Pitcher Barrel sampler (see Figure E below). Material recovered over the length of the sampler is shaded. A measure of resistance is not collected with this technique.

Blow counts are converted to SPT counts which are shown on the boring logs by the following relation:

$$B = \frac{NWH}{(140)(30)} \left(\frac{D_o^{SPT^2} - D_i^{SPT^2}}{D_o^2 - D_i^2} \right)$$

B = Equivalent number of blows per foot with a SPT

N = Number of blows per foot actually recorded

W = Weight of hammer (lb)

H = Height of hammer drop (in)

D_o = Outside Diameter (in)

D_i = Inside Diameter (in)

The blow counts used for these conversions were taken over the last two sample intervals if the sampler was driven 12 inches or more. If the sampler is driven less than 12 inches, the blow counts of the last sample were converted to SPT counts of 50 blows over an equivalent SPT run length.



SPT
Figure A



2" Liner
Figure B



2.5" Liner
Figure C

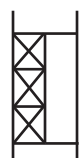

1" Liner
Figure D



Pitcher Barrel
Figure E

■ = Undisturbed Sample

⊠ = Disturbed Sample

Where obtained, the shear strength of the soil samples is shown on the boring logs in far right-hand column.

SUMMARY OF FIELD SAMPLING PROCEDURES



ZAHEDI PROPERTY
12400 Skyline Boulevard
San Mateo County, California

DOCUMENT ID.

DATE

22033C-01R1

May 2022

Figure 7

EQUIPMENT	Truck-Mounted Mobile B-24	RELATIVE ELEVATION	1710 feet	LOGGED BY	K. Kiefer					
DEPTH TO GROUNDWATER	Not Encountered	DEPTH TO BEDROCK	2 feet	DATE DRILLED	5-2-2022					
DESCRIPTION AND CLASSIFICATION										
DESCRIPTION AND REMARKS	CONSIST.	SOIL TYPE	DEPTH (FEET)	SAMPLE	PENETRATION RESISTANCE (BLOWS / FT.)	WATER CONTENT (%)	DRY DENSITY (PCF)	SHEAR STRENGTH (KSF)		
<p>SANDY SILT; very dark grayish brown (10YR 3/2); homogeneous; trace fine-grained sand; subangular sandstone fragments; low plasticity; scattered rootlets; moist (Colluvium)</p> <p>SANDSTONE; brownish yellow (10YR 6/6); moderate to closely fractured; low to moderate hardness; friable to moderate strength; moderate to deeply weathered; medium to coarse-grained sand; indistinct bedding; moist (Bedrock)</p> <p>siltstone interbed</p>	Stiff	ML (Rock)	-							
			- 1 -		12	18	98			
			- 2 -		13					
			- 3 -		16					
			- 4 -							
			- 5 -							
			- 6 -							
			- 7 -							
			- 8 -							
			- 9 -							
			- 10 -							
			- 11 -			23	26	101		
			- 12 -							
			- 13 -							
			- 14 -							
			- 15 -							
- 16 -			84							
Bottom of Boring = 16½ feet			- 17 -							
			- 18 -							
			- 19 -							
			- 20 -							

LOG OF BORING 1



ZAHEDI PROPERTY
12400 Skyline Boulevard
San Mateo County, California

DOCUMENT ID.

DATE

22033C-01R1

May 2022

Figure 8

EQUIPMENT	Truck-Mounted Mobile B-24	RELATIVE ELEVATION	1698 feet	LOGGED BY	K. Kiefer				
DEPTH TO GROUNDWATER	Not Encountered	DEPTH TO BEDROCK	4 feet	DATE DRILLED	5-2-2022				
DESCRIPTION AND CLASSIFICATION									
DESCRIPTION AND REMARKS	CONSIST.	SOIL TYPE	DEPTH (FEET)	SAMPLE	PENETRATION RESISTANCE (BLOWS / FT.)	WATER CONTENT (%)	DRY DENSITY (PCF)	SHEAR STRENGTH (KSF)	
<p>SANDY SILT; very dark grayish brown (10YR 3/2) to grayish brown (10YR 5/2); homogeneous; trace fine-grained sand; subangular sandstone fragments; low plasticity; scattered rootlets; moist (Colluvium)</p> <hr/> <p>SANDSTONE; brownish yellow (10YR 6/6); moderate to closely fractured; low to moderate hardness; friable to moderate strength; moderate to deeply weathered; medium to coarse-grained sand; indistinct bedding; moist (Bedrock)</p>	Stiff to Medium Stiff	ML	-						
			-1-			10	19	98	
			-2-			6			
			-3-						
			-4-		(Rock)	9			
			-5-						
			-6-						
			-7-			30	15	109	
			-8-						
			-9-						
			-10-						
			-11-			19	17	109	
			-12-						
			-13-						
			-14-						
			-15-						
-16-					16				
Bottom of Boring = 16½ feet			-17-						
			-18-						
			-19-						
			-20-						

LOG OF BORING 2



ZAHEDI PROPERTY
12400 Skyline Boulevard
San Mateo County, California

DOCUMENT ID.

DATE

22033C-01R1

May 2022

Figure 9

EQUIPMENT	Truck-Mounted Mobile B-24	RELATIVE ELEVATION	1687 feet	LOGGED BY	K. Kiefer				
DEPTH TO GROUNDWATER	Not Encountered	DEPTH TO BEDROCK	1¼ feet	DATE DRILLED	5-2-2022				
DESCRIPTION AND CLASSIFICATION									
DESCRIPTION AND REMARKS	CONSIST.	SOIL TYPE	DEPTH (FEET)	SAMPLE	PENETRATION RESISTANCE (BLOWS / FT.)	WATER CONTENT (%)	DRY DENSITY (PCF)	SHEAR STRENGTH (KSF)	
<p>SANDY SILT; very dark grayish brown (10YR 3/2); homogeneous; trace fine-grained sand; subangular sandstone fragments; low plasticity; trace roots and scattered rootlets; moist (Colluvium)</p> <hr style="border-top: 1px dashed black;"/> <p>SANDSTONE; brownish yellow (10YR 6/6); moderate to closely fractured; low to moderate hardness; friable to moderate strength; moderate to deeply weathered; medium to coarse-grained sand; indistinct bedding; moist (Bedrock)</p>	Medium Stiff	ML	-						
		(Rock)	-1-			10			
			-2-						
			-3-			46			
			-4-			18			
			-5-						
			-6-						
			-7-						
			-8-						
			-9-						
			-10-						
	-11-				12	17	106		
Bottom of Boring = 11½ feet			-12-						
			-13-						
			-14-						
			-15-						
			-16-						
			-17-						
			-18-						
			-19-						
			-20-						

LOG OF BORING 3



ZAHEDI PROPERTY
12400 Skyline Boulevard
San Mateo County, California

DOCUMENT ID.

DATE

22033C-01R1

May 2022

Figure 10

BENCH DIAGRAM

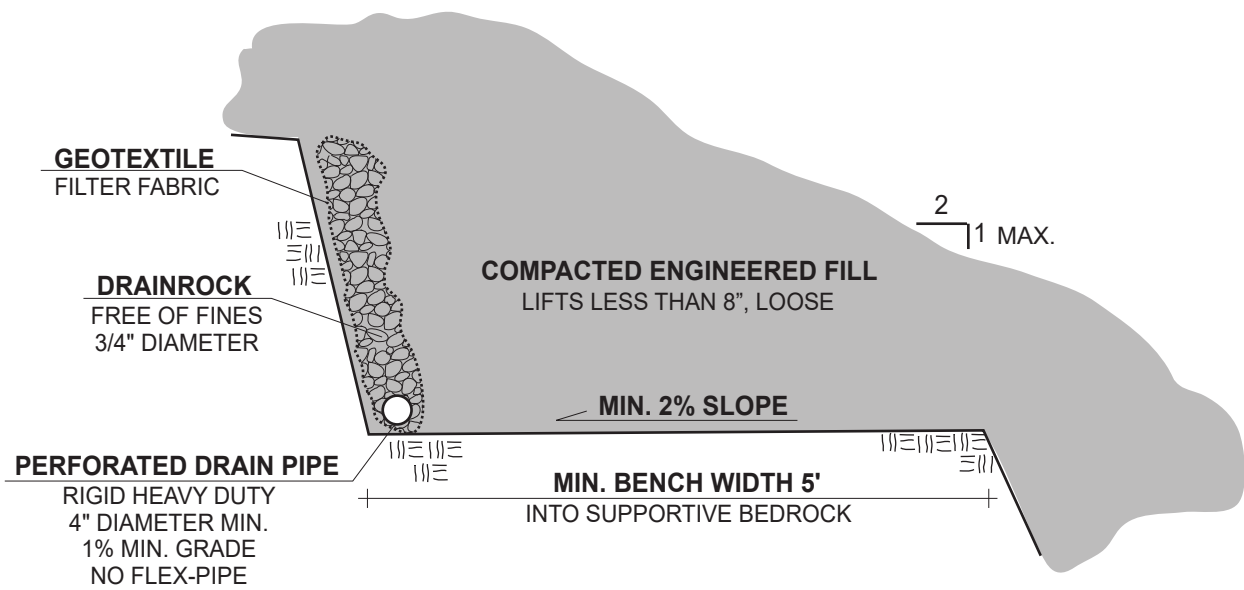

KEYWAY DIAGRAM

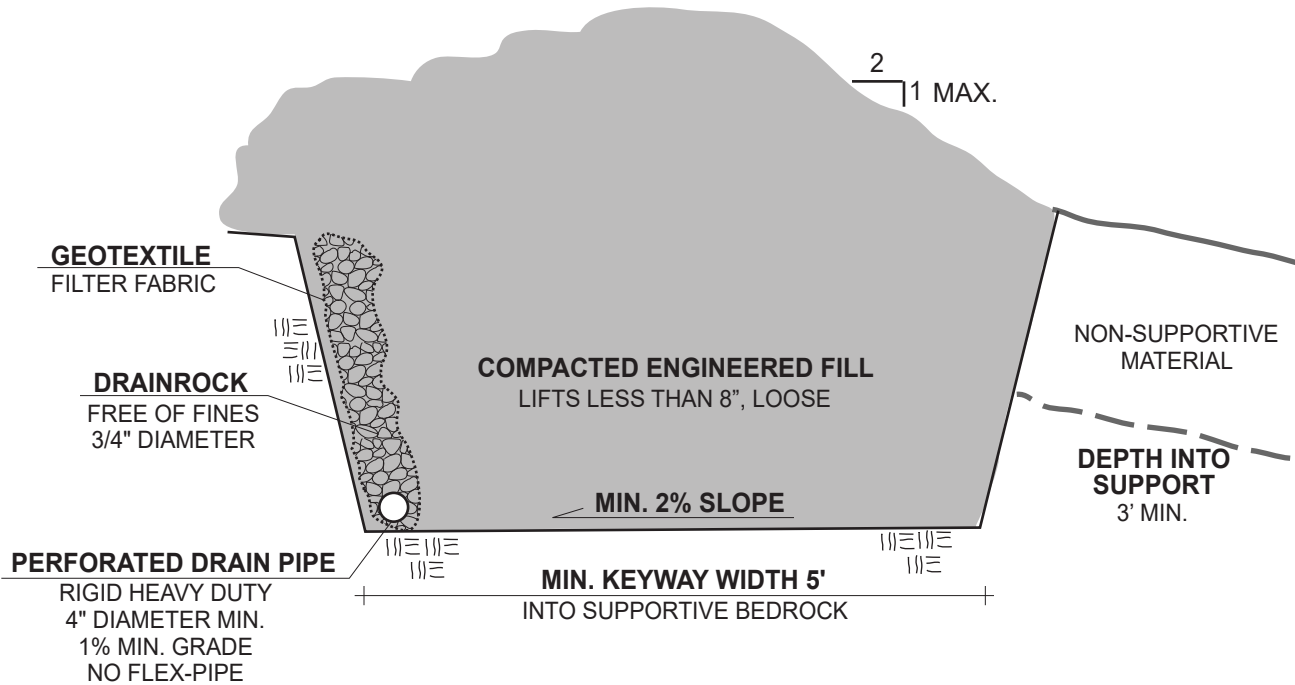

CONCEPTUAL ENGINEERED FILL AND SUBDRAIN DIAGRAM



ZAHEDI PROPERTY
12400 Skyline Boulevard
San Mateo County, California

DRAFTED/REVIEWED

SCALE

DOCUMENT ID.

DATE

KK/CH

Not Applicable

22033C-01R1

May 2022

Figure 11

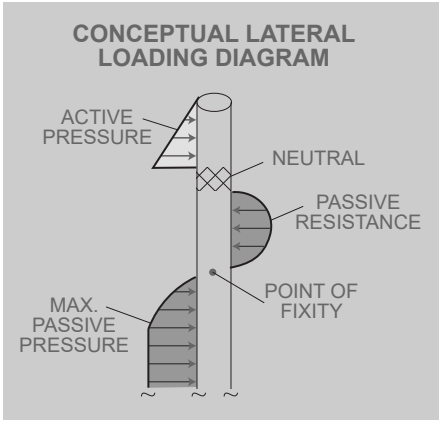
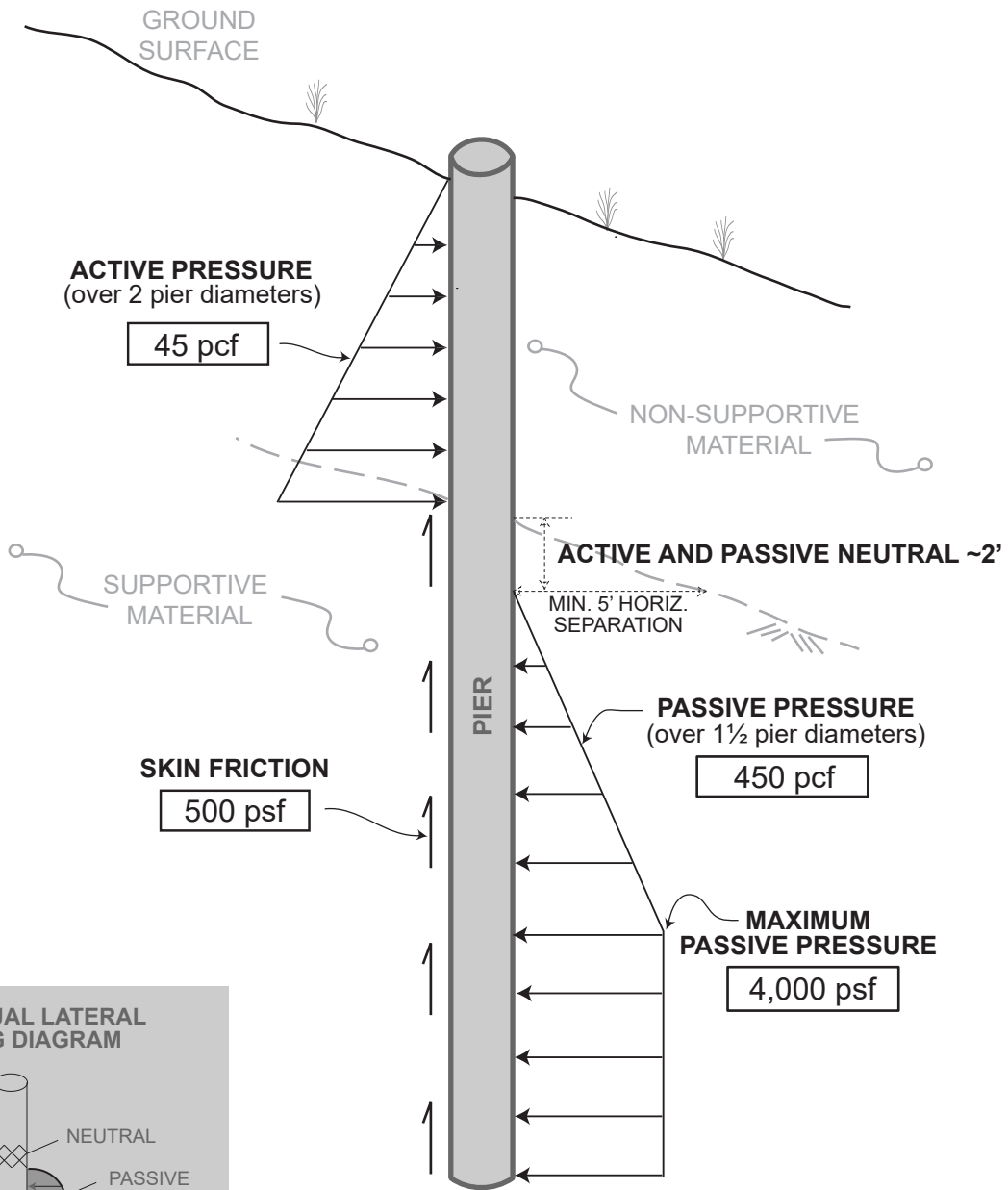

CONCEPTUAL PIER PRESSURE DIAGRAM



ZAHEDI PROPERTY
 12400 Skyline Boulevard
 San Mateo County, California

DRAFTED/REVIEWED	SCALE	DOCUMENT ID.	DATE	Figure 12
KK/CH	Not Applicable	22033C-01R1	May 2022	

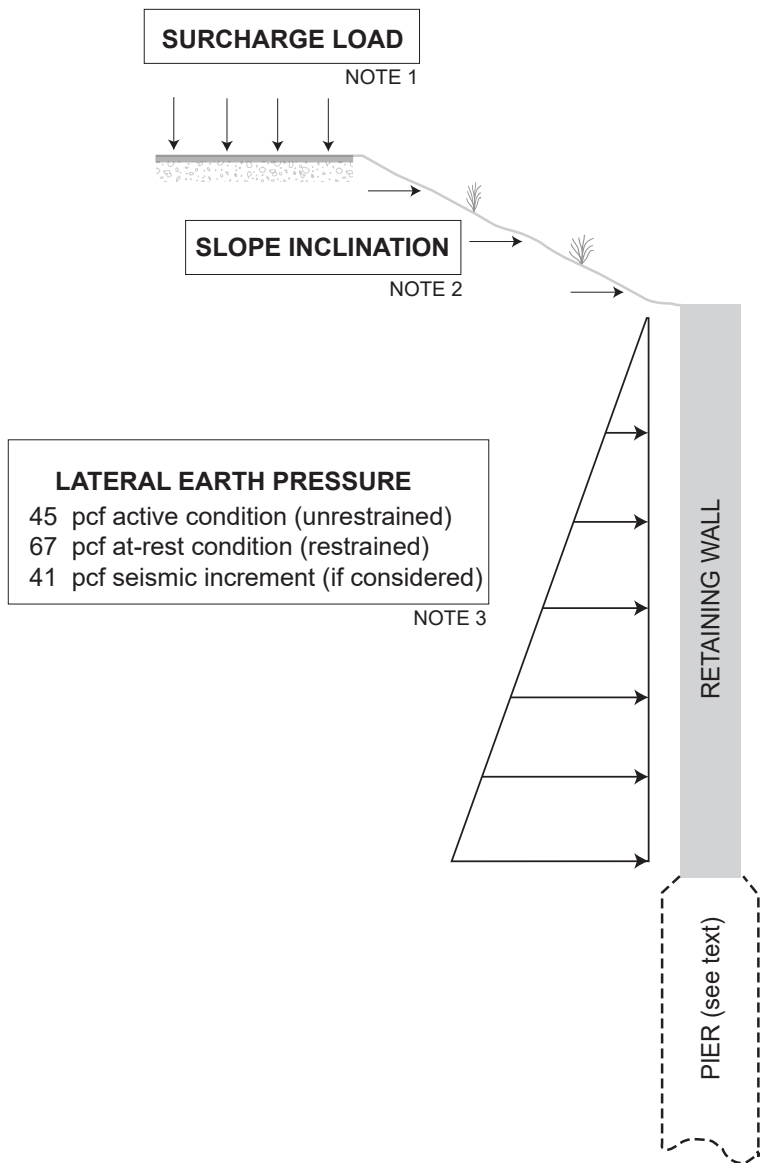

LATERAL EARTH PRESSURE
 45 pcf active condition (unrestrained)
 67 pcf at-rest condition (restrained)
 41 pcf seismic increment (if considered)
 NOTE 3

NOTE 1: Additional lateral load equal to 1/3 (unrestrained) or 1/2 (restrained) the anticipated surcharge load.

NOTE 2: Add an additional equivalent fluid pressure increment to the active and at-rest condition for sloping backfill above the wall where inclinations are greater than 4:1 (horizontal to vertical), as follows:

- +8 pcf for slope inclinations between 3:1 and 4:1
- +12 pcf for slope inclinations between 2:1 and 3:1

NOTE 3: Lateral earth pressures are shown for drained retaining walls. Contact us to provide additional recommendations if undrained walls are planned.

CONCEPTUAL RETAINING WALL PRESSURE DIAGRAM



ZAHEDI PROPERTY
 12400 Skyline Boulevard
 San Mateo County, California

DRAFTED/REVIEWED	SCALE	DOCUMENT ID.	DATE	Figure 13
KK/CH	Not Applicable	22033C-01R1	May 2022	

FOR LAGGING WALLS

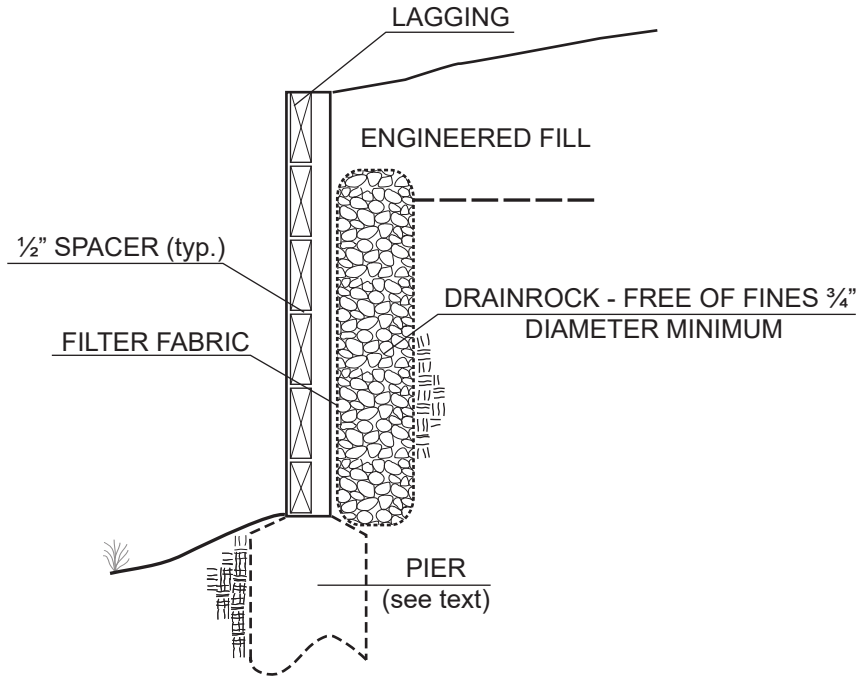

FOR CONCRETE WALLS

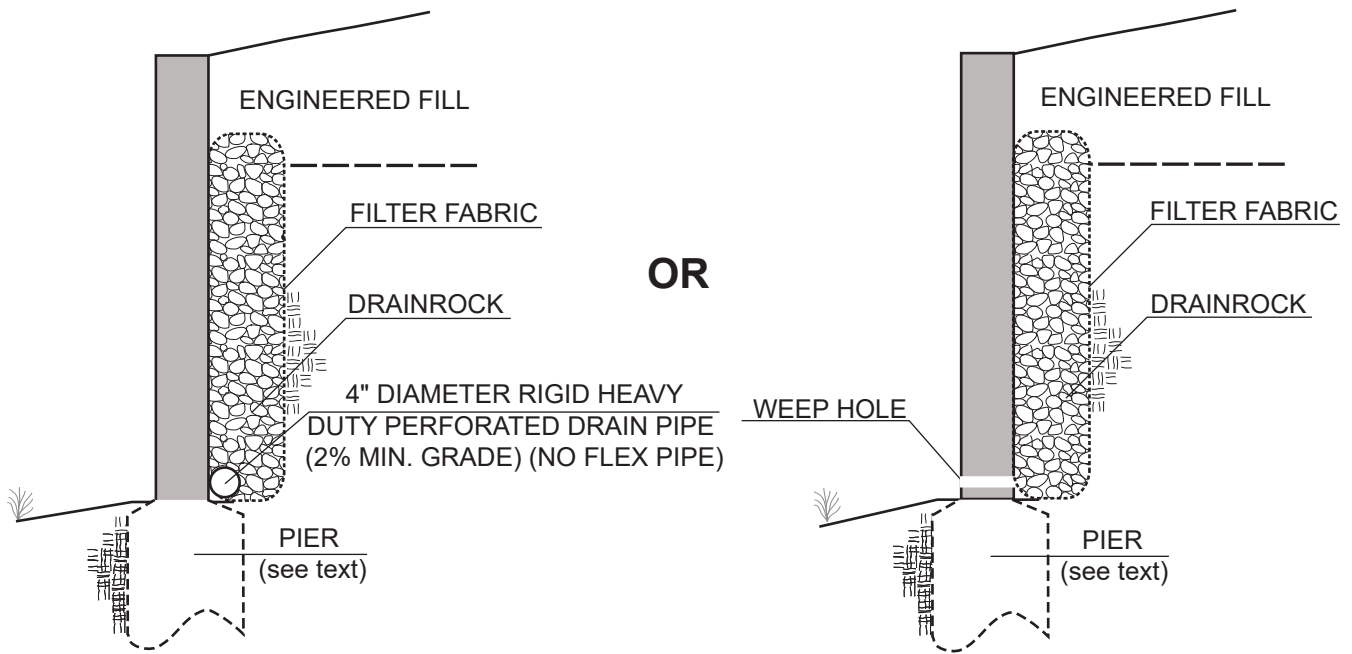

CONCEPTUAL RETAINING WALL BACKDRAIN DIAGRAM



ZAHEDI PROPERTY
 12400 Skyline Boulevard
 San Mateo County, California

DRAFTED/REVIEWED	SCALE	DOCUMENT ID.	DATE	Figure 14
KK/CH	Not Applicable	22033C-01R1	May 2022	

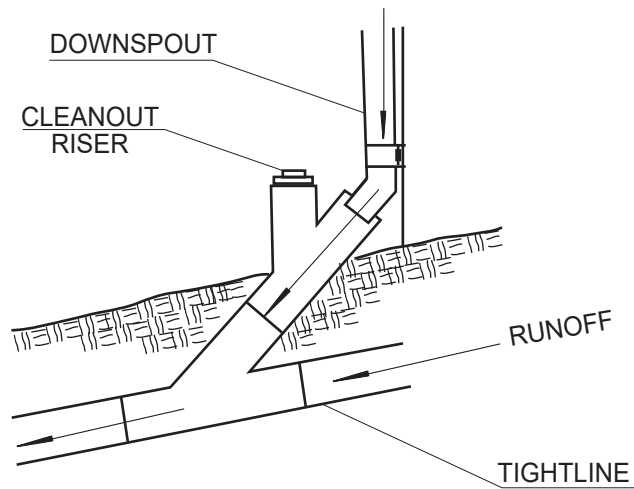

CONCEPTUAL DOWNSPOUT CLEANOUT DIAGRAM



ZAHEDI PROPERTY
 12400 Skyline Boulevard
 San Mateo County, California

DRAFTED/REVIEWED	SCALE	DOCUMENT ID.	DATE	Figure 15
KK/CH	Not Applicable	22033C-01R1	May 2022	

PERSPECTIVE VIEW

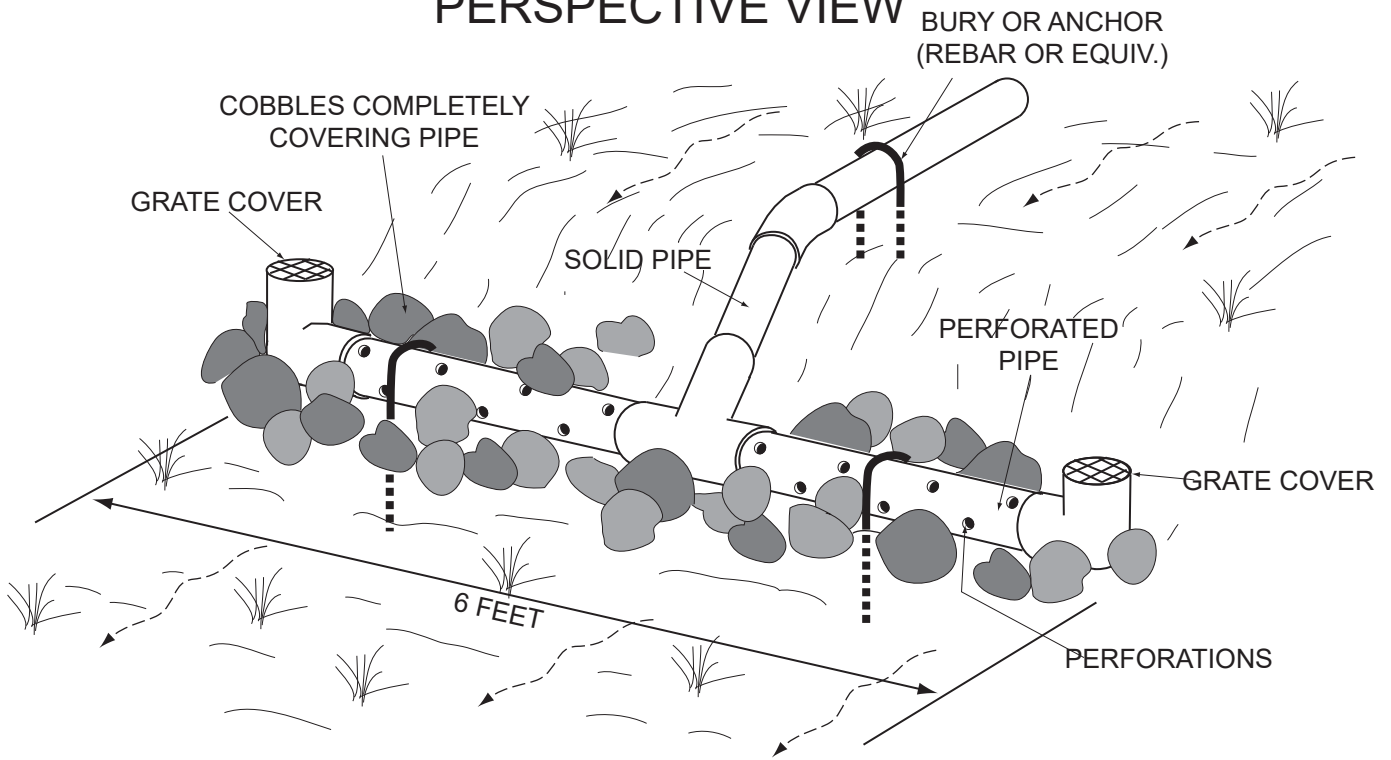

NOTE: PERFORATED PIPE MUST BE LEVEL
(PERFORATIONS FACING DOWNSLOPE)

SECTION VIEW

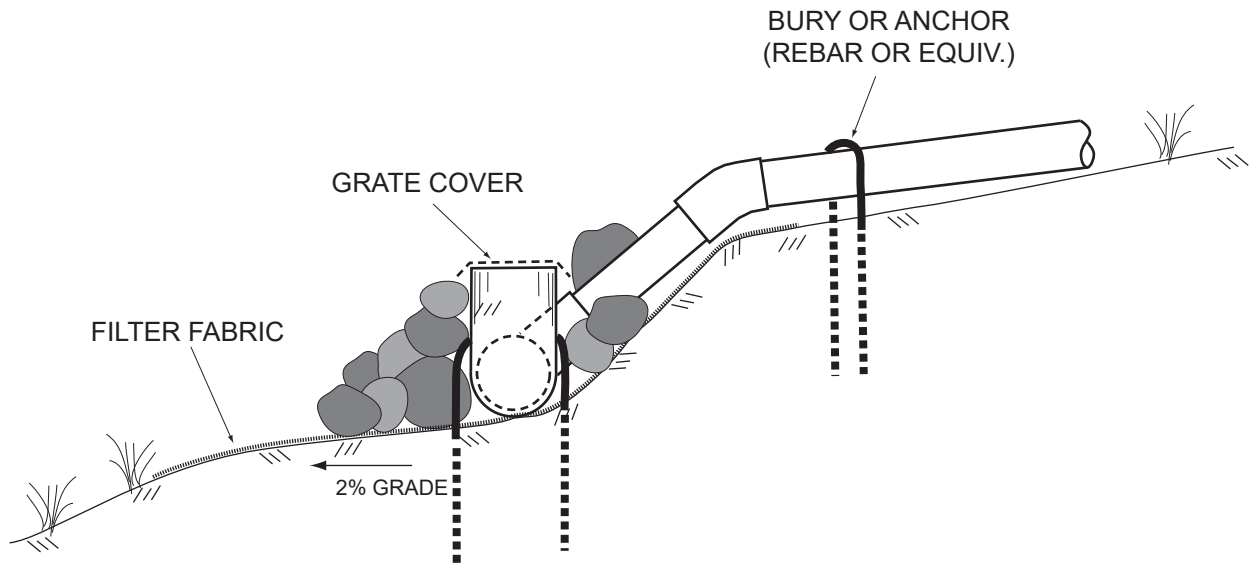

CONCEPTUAL ENERGY DISSIPATER DIAGRAM



ZAHEDI PROPERTY
12400 Skyline Boulevard
San Mateo County, California

DRAFTED/REVIEWED	SCALE	DOCUMENT ID.	DATE	Figure 16
KK/CH	Not Applicable	22033C-01R1	May 2022	



APPENDIX: ASCE 7 HAZARDS REPORTS



ASCE 7 Hazards Report

Address:
12400 Skyline Blvd
Redwood City, California
94062

Standard: ASCE/SEI 7-16
Risk Category: II
Soil Class: C - Very Dense
Soil and Soft Rock

Elevation: 1705.11 ft (NAVD 88)
Latitude: 37.464175
Longitude: -122.34697

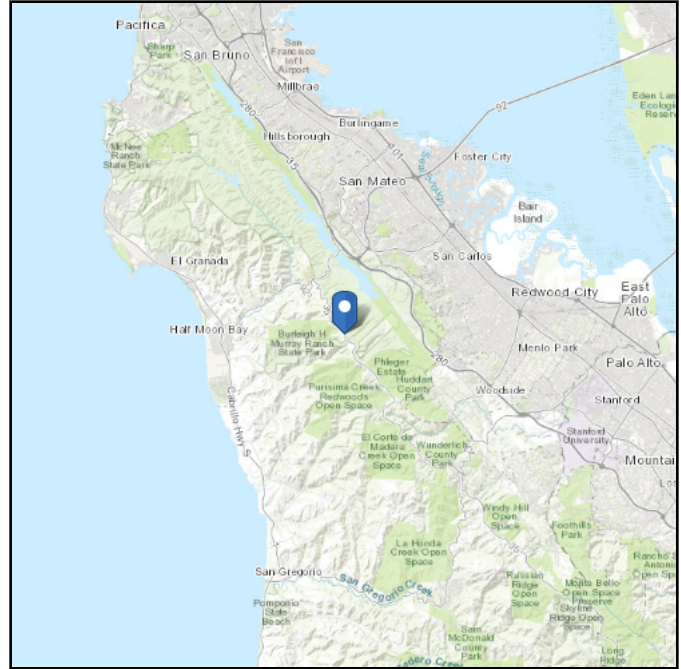
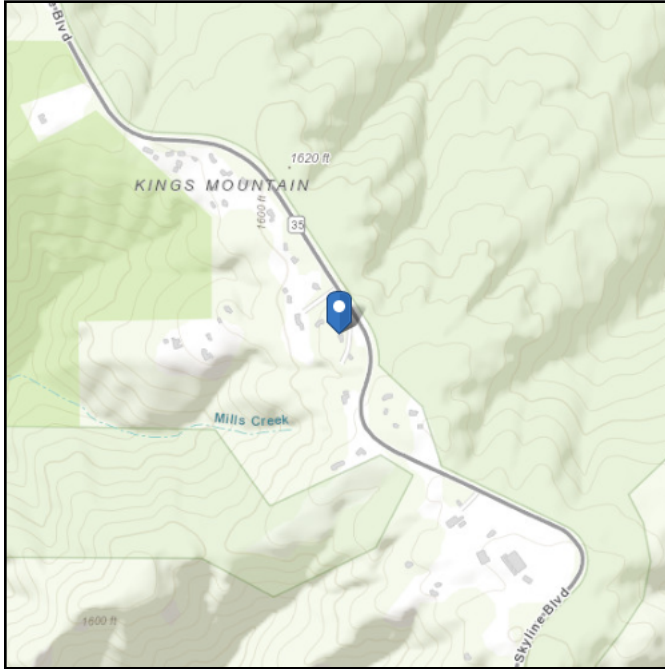

Site Soil Class: C - Very Dense Soil and Soft Rock

Results:

S_S :	2.365	S_{D1} :	0.854
S_1 :	0.915	T_L :	12
F_a :	1.2	PGA :	0.977
F_v :	1.4	PGA _M :	1.172
S_{MS} :	2.839	F_{PGA} :	1.2
S_{M1} :	1.281	I_e :	1
S_{DS} :	1.892	C_v :	1.3

Seismic Design Category E

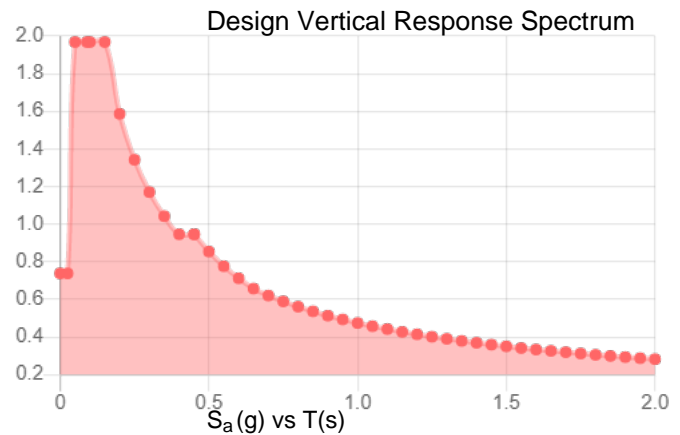
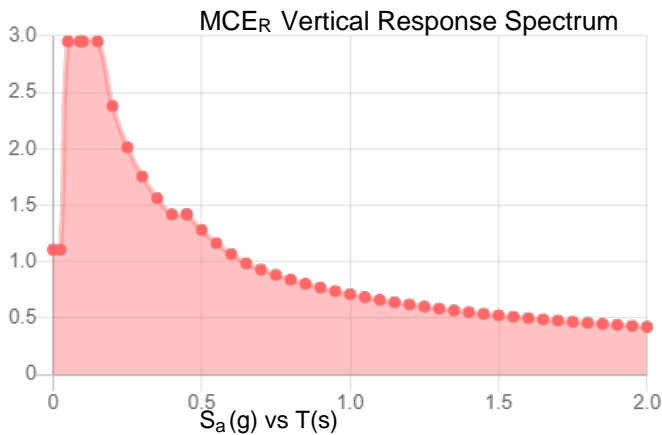
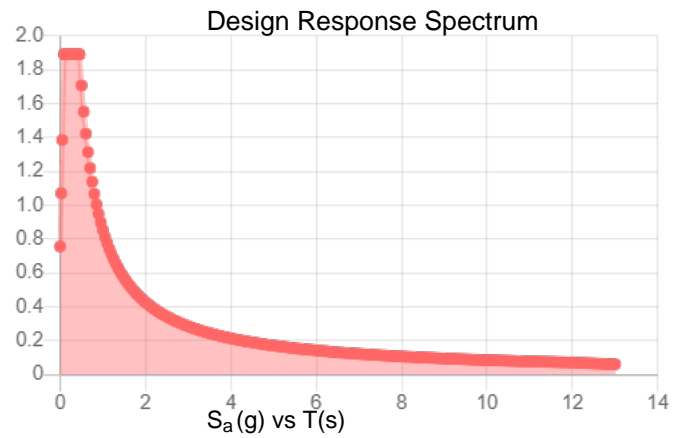
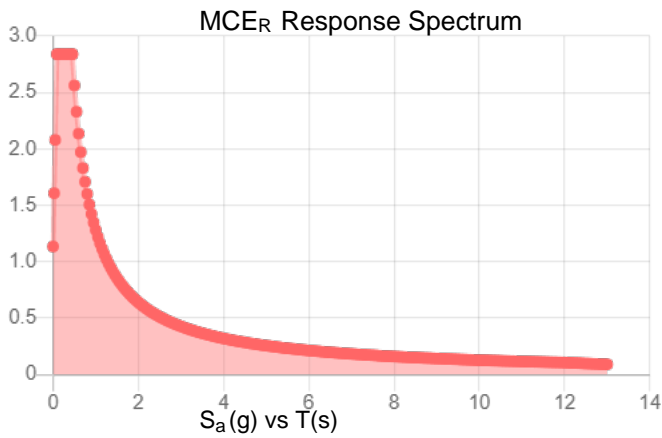

Data Accessed: Thu May 26 2022

Date Source:

USGS Seismic Design Maps based on ASCE/SEI 7-16 and ASCE/SEI 7-16 Table 1.5-2. Additional data for site-specific ground motion procedures in accordance with ASCE/SEI 7-16 Ch. 21 are available from USGS.

The ASCE 7 Hazard Tool is provided for your convenience, for informational purposes only, and is provided “as is” and without warranties of any kind. The location data included herein has been obtained from information developed, produced, and maintained by third party providers; or has been extrapolated from maps incorporated in the ASCE 7 standard. While ASCE has made every effort to use data obtained from reliable sources or methodologies, ASCE does not make any representations or warranties as to the accuracy, completeness, reliability, currency, or quality of any data provided herein. Any third-party links provided by this Tool should not be construed as an endorsement, affiliation, relationship, or sponsorship of such third-party content by or from ASCE.

ASCE does not intend, nor should anyone interpret, the results provided by this Tool to replace the sound judgment of a competent professional, having knowledge and experience in the appropriate field(s) of practice, nor to substitute for the standard of care required of such professionals in interpreting and applying the contents of this Tool or the ASCE 7 standard.

In using this Tool, you expressly assume all risks associated with your use. Under no circumstances shall ASCE or its officers, directors, employees, members, affiliates, or agents be liable to you or any other person for any direct, indirect, special, incidental, or consequential damages arising from or related to your use of, or reliance on, the Tool or any information obtained therein. To the fullest extent permitted by law, you agree to release and hold harmless ASCE from any and all liability of any nature arising out of or resulting from any use of data provided by the ASCE 7 Hazard Tool.



ASCE 7 Hazards Report

Address:
12400 Skyline Blvd
Redwood City, California
94062

Standard: ASCE/SEI 7-22
Risk Category: II
Soil Class: BC

Elevation: 1705.11 ft (NAVD 88)
Latitude: 37.464175
Longitude: -122.34697

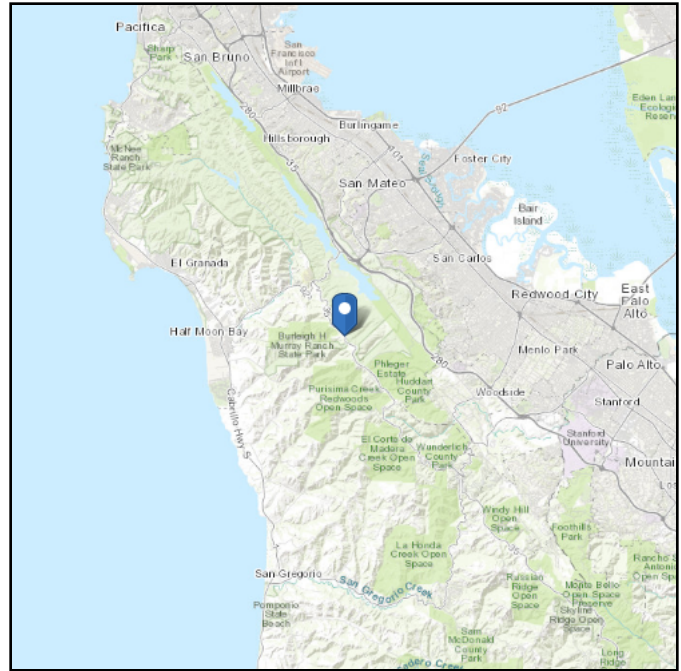
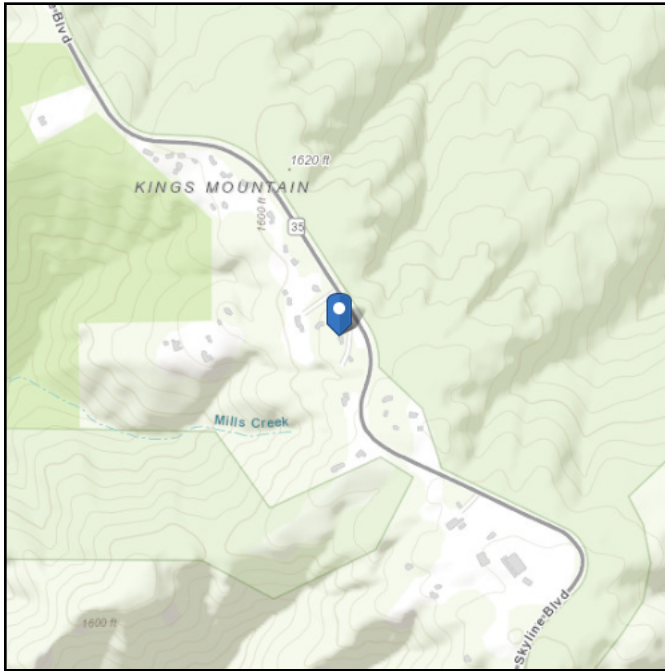

Site Soil Class:

Results:

PGA _M :	0.95	T _L :	12
S _{MS} :	2.45	S _S :	2.72
S _{M1} :	1.01	S ₁ :	1.01
S _{DS} :	1.63	S _{DC} :	
S _{D1} :	0.67	V _{S30} :	760

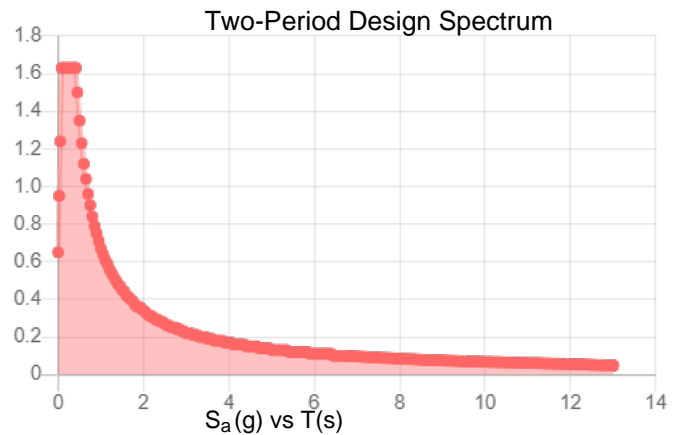
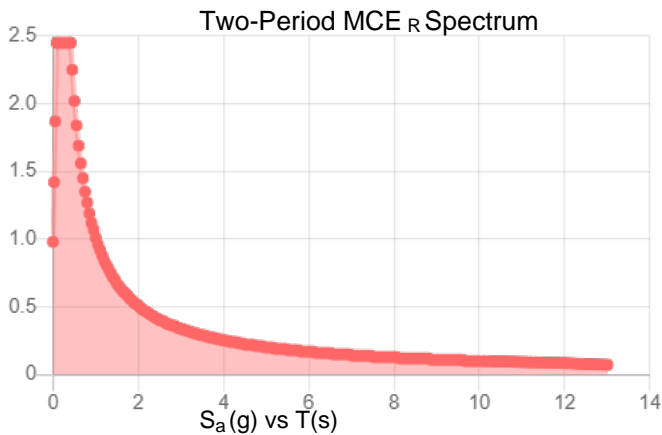
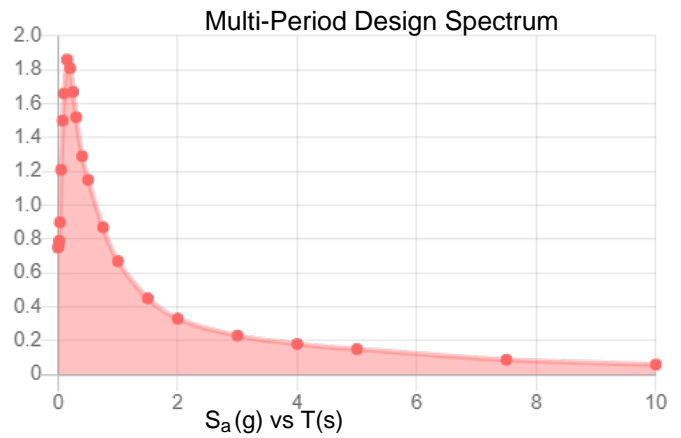
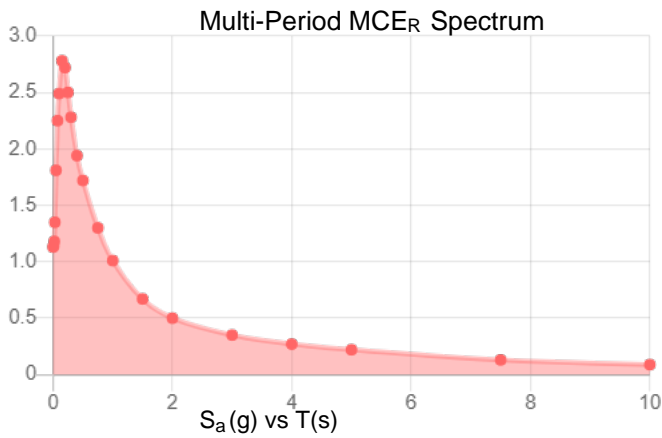

MCE_R Vertical Response Spectrum
Vertical ground motion data has not yet been made available by USGS.

Design Vertical Response Spectrum
Vertical ground motion data has not yet been made available by USGS.



Data Accessed: Thu May 26 2022

Date Source:

USGS Seismic Design Maps based on ASCE/SEI 7-22 and ASCE/SEI 7-22 Table 1.5-2. Additional data for site-specific ground motion procedures in accordance with ASCE/SEI 7-22 Ch. 21 are available from USGS.

The ASCE 7 Hazard Tool is provided for your convenience, for informational purposes only, and is provided “as is” and without warranties of any kind. The location data included herein has been obtained from information developed, produced, and maintained by third party providers; or has been extrapolated from maps incorporated in the ASCE 7 standard. While ASCE has made every effort to use data obtained from reliable sources or methodologies, ASCE does not make any representations or warranties as to the accuracy, completeness, reliability, currency, or quality of any data provided herein. Any third-party links provided by this Tool should not be construed as an endorsement, affiliation, relationship, or sponsorship of such third-party content by or from ASCE.

ASCE does not intend, nor should anyone interpret, the results provided by this Tool to replace the sound judgment of a competent professional, having knowledge and experience in the appropriate field(s) of practice, nor to substitute for the standard of care required of such professionals in interpreting and applying the contents of this Tool or the ASCE 7 standard.

In using this Tool, you expressly assume all risks associated with your use. Under no circumstances shall ASCE or its officers, directors, employees, members, affiliates, or agents be liable to you or any other person for any direct, indirect, special, incidental, or consequential damages arising from or related to your use of, or reliance on, the Tool or any information obtained therein. To the fullest extent permitted by law, you agree to release and hold harmless ASCE from any and all liability of any nature arising out of or resulting from any use of data provided by the ASCE 7 Hazard Tool.



APPLICATION TO USE

NOTE: THIS APPLICATION FOR AUTHORIZATION TO USE THIS COPYRIGHTED DOCUMENT MUST BE COMPLETED FOR USE OR COPYING OF THE FOLLOWING DOCUMENT BY ANYONE OTHER THAN THE CLIENT.

GEOTECHNICAL STUDY
PROPOSED DWELLING WITH ATTACHED GARAGE

ZAHEDI PROPERTY
12400 SKYLINE BOULEVARD
SAN MATEO COUNTY, CALIFORNIA

DOCUMENT ID. 22033C-01R1
DATED 27 May 2022

TO: C2Earth, Inc.
750 Camden Avenue, Suite A
Campbell, CA 95008

FROM: _____

Please clearly identify name and address of person/entity applying to use or copy this document.

APPLICANT: _____ hereby applies for permission to use the above referenced document for the following purpose(s):

Applicant understands and agrees that the document listed above is a copyrighted document, that C2Earth, Inc. is the copyright owner and that unauthorized use or copying of the document is strictly prohibited without the express written permission of C2Earth, Inc. Applicant understands that C2Earth, Inc. may withhold such permission at its sole discretion, or grant such permission upon such terms and conditions as it deems acceptable, such as the execution of a Hold Harmless Agreement or the payment of a re-use fee.

Signature: _____

Date: _____