

Living on

SHAKY GROUND

HOW TO SURVIVE EARTHQUAKES AND TSUNAMIS IN NORTHERN CALIFORNIA



New Edition 2023

You Can Prepare for the Next Quake or Tsunami

Congratulations. You are taking the first step to making an earthquake-safe home for yourself and your family.

Knowing what to do and preparing NOW will:

- Reduce injuries
- Reduce losses
- Reduce worry and fear
- Get you and your family back on your feet

Practice What To Do in an Earthquake in the **Great ShakeOut Drill**



[ShakeOut](#)

Trained personnel may not reach you for many days after a major disaster.

Individuals, families, neighborhoods, and communities can reduce risks and help each other in the critical time period before outside assistance can reach you.

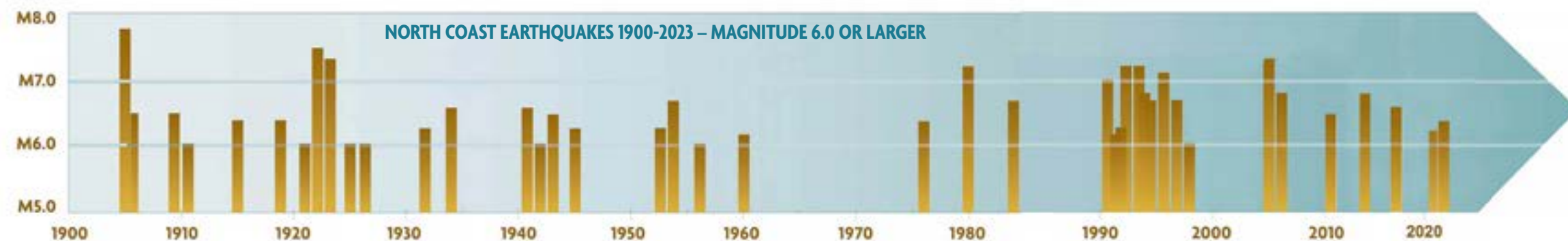

During an Earthquake, Stay in One Place

INDOORS

DROP to the ground and take **COVER** under a nearby table or other furniture. **HOLD ON** to it and stay put until the shaking stops.

- **CAN'T SAFELY DROP TO THE FLOOR?** Stay where you are. Bend over and protect your neck and head with your arms.
- **IN BED?** Stay put, use your pillow to protect your head and neck.

STAY INSIDE. You may be injured by breaking glass and falling objects if you run outside.

OUTDOORS

- Move away from power lines and trees. Drop to the ground, and stay put until the shaking stops.
- Think **TSUNAMI**. If you are at the coast, **HEAD TO HIGHER GROUND OR INLAND** away from the ocean as soon as it is safe to move.

DRIVING

- Slow down and move to the shoulder.
- Stay away from structures or objects that could fall on you, such as bridges, overhead passes, light posts, power lines, or trees.

STAY INSIDE YOUR CAR.

Protect yourself when an earthquake happens – the best thing to do depends on your situation and abilities. More information on page 28.

Find additional information throughout this magazine by **SCANNING** the QR codes or **CLICKING** the underlined blue text.



[Find earthquake and tsunami information on the Redwood Coast Tsunami Work Group website](#)

This magazine is intended for residents and visitors to Northern California north of Santa Rosa. Much of the information is relevant everywhere but some is specific to this area. Contact your county or state for the best guidance for other regions. The information is based on the consensus of scientific and emergency professionals as of 2023. It may change as more is learned about earthquakes and tsunamis.

INDOORS?



IN BED?



IN A WHEELCHAIR?

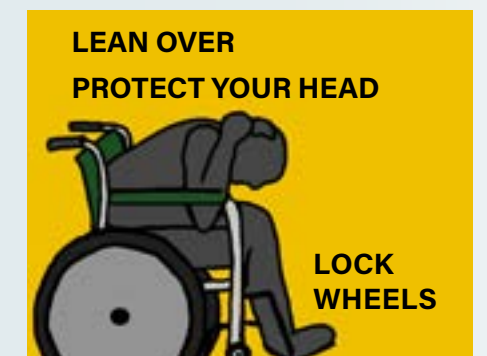

IN A TSUNAMI ZONE?



After an Earthquake, Evacuate if in a Tsunami Hazard Area

Head to higher ground or inland as soon as it is safe to walk. Do not wait for official notification; tsunami surges could arrive in minutes. Stay away from the coast until officials permit you to return.

OUTSIDE A TSUNAMI ZONE: Check for injuries. Do not move seriously injured people unless they are in immediate danger. Follow the guidelines on page 30.

EXPECT AFTERSHOCKS. Aftershocks following large earthquakes can be large and damaging and continue for months or years.

Answer These Questions BEFORE a Disaster

How will I reach my family members?

Your family disaster plan should include:

- What to do if your children are at school, daycare, or other activities. Ask staff about emergency plans.
 - Who will take care of pets or livestock if you are away from home.
 - Identify an out-of-the-area contact to convey information to family members and friends.
- Discuss your plans with everyone in your family.

Phones and Internet may be disrupted or overwhelmed. Roads may be damaged making it difficult, unsafe, or impossible to travel.

Where will I get medical help?

- Take first aid and CPR classes to help you respond to medical emergencies.
- Plan for back-up power if family members require electricity for life-saving medical equipment.
- Have a basic first aid kit.

The 9-1-1 system could be disrupted, ambulances might not be able to reach you, and medical facilities may not be operational.

Am I prepared to live without the essentials?

- Store water at home, work, and in your car.
- Keep at least one week's worth – and preferably a month's worth – of food, water, and medicine for everyone in your family.
- Keep your gas tank at least half full or your electric vehicle half charged.

Utilities and water supplies may be disrupted for weeks.

How will I pay for things?

- Keep cash on hand.

ATMs may not work and businesses may only accept cash.

How will I repair the damage to my home?

- Examine what your insurance covers and consider earthquake and or flood insurance.
- Minimize losses by taking action to reduce hazards.

Use a cell phone or camera to document your home and valuable belongings now. Document again after a disaster.

Do I live, work, or visit in a tsunami zone?

- If you are in a tsunami zone, identify evacuation routes beforehand — after feeling an earthquake, evacuate as soon as it is safe to move. You may have ten minutes or less to reach a safe zone on foot.
- **Out of a tsunami zone? Stay put.** You do not have to evacuate.

There may be no time for an official tsunami warning to reach you if the source of the tsunami is nearby.

Who is Going to Save You?

YOU AND YOUR NEIGHBORS!

A major earthquake could overwhelm local law enforcement, fire, and emergency medical personnel and resources. Outside assistance may take a week or more to provide basic relief, especially for remote areas of Northern California.

The first step is to **TALK** to your family, housemates, and co-workers about what your risks are at home, in your workplace, or areas you visit. Having an emergency plan and pulling supplies together will make a difference in a disaster.

PREPARING FOR EARTHQUAKES AND TSUNAMIS WILL HELP PREPARE YOU FOR OTHER DISASTERS INCLUDING FIRES, WINTER STORMS, AND FLOODS

FOOD AND WATER FOR TWO WEEKS

This is what two people need for two weeks. If you live in a rural area, it could take longer for outside assistance to reach you.



WATER

CANNED GOODS: VEGETABLES, FRUITS, BEANS, SOUPS

GRAINS, CEREAL, PROTEIN BARS

COFFEE, TEA, BEVERAGES

PROTEINS: NUTS, CANNED TUNA, JERKY

DRIED FRUIT

BREAD AND CRACKERS

CONDIMENTS, SPICES



[Emergency food for 7 days](#)

You Live in Earthquake Country

NORTHERN CALIFORNIA (north of Santa Rosa) with its mountains, coast, and dramatic vistas is a beautiful place to live. Geologic forces created our environment and reshapes the land. The North Coast is the most earthquake-prone spot in the contiguous United States.

How seriously this area is impacted and how quickly we recover from the next large Northern California earthquake

is a matter of what you know and actions you and your community take to reduce hazards.

California's North Coast is unique. Three plates and three major fault systems meet near Cape Mendocino. Called the Mendocino triple junction, each poses seismic threats, and the complex interaction is responsible for the region's earthquakes.



[Triple
Junction
Video](#)



[USGS
Plate
Tectonics](#)

NORTH COAST FAULTS

Faults are weak zones in the earth's crust where the rocks move relative to each other. Some faults, like the San Andreas, are vertical and the two sides move horizontally sliding past each other like cars on a freeway. Other faults form where the land is stretched like the Basin and Range. The largest faults are in subduction zones where the forces are compressional. Thrust faults, where the rock on one side is pushed up and over the rock on the other side predominate in subduction zones.

HIDDEN FAULTS

All earthquakes occur on faults but not all of our faults are easy to see. Many are offshore and can only be studied remotely (Gorda Plate faults, Mendocino fault, and Cascadia subduction zone). Others are covered by forests or are in inaccessible terrain. Our subduction zone creates an additional complication with deeper faults that can cause earthquakes not matching up with faults on the surface.

PLATE TECTONICS

The earth consists of layers. The outermost layer is roughly 80 miles thick and is relatively cold and stiff compared to the warmer regions below. It is broken into pieces called plates which move slowly relative to each other. A plate boundary is where one plate meets another.

Most but not all earthquakes occur at or near the boundaries between plates. The most seismically active plate boundaries are subduction zones where gravity slowly pulls one plate beneath another. Subduction zones are where the largest earthquakes on the planet occur.

EARTHQUAKES AND FAULTS

An earthquake occurs when rocks beneath the earth's surface break (rupture), usually along an existing zone of weakness (fault). Rupture begins miles below the surface (source) and grows as the rock on each side slips past each other. The longer the fault ruptures, the larger the earthquake magnitude. The epicenter is the spot on the ground surface directly above the point where the rupture starts. Seismic waves travel out from the source area while the fault ruptures.

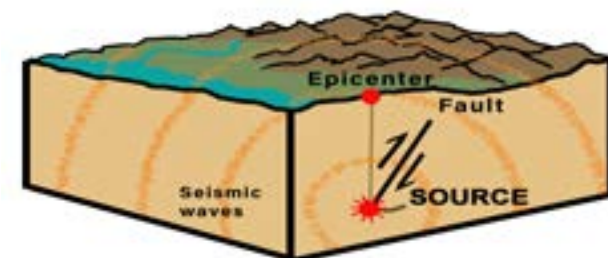

ALL AREAS OF NORTHERN CALIFORNIA HAVE EXPERIENCED EARTHQUAKES IN THE PAST AND WILL AGAIN IN THE FUTURE



Where Earthquakes Have Occurred in the Past, They Will Happen Again

The size, location, and how often earthquakes occur give an indication of what to expect in the future. Since the mid-1800s, more than 40 earthquakes of magnitude (*M*) 6 or larger have occurred in California north of Santa Rosa and in adjacent offshore areas.



Ferndale General Mercantile after the 1906 earthquake.

Not all earthquakes that affect Northern California are centered nearby. Great earthquakes along the Pacific rim like the 1964 *M* 9.2 Alaska earthquake and 2011 *M* 9.1 Japan earthquake generate tsunamis that can hit our coast.



Bricks from the same building fell during the April 1992 earthquake. The building has now been replaced by a wooden structure.

Notable Earthquakes (*M* is magnitude)

January 26, 1700 Cascadia subduction zone – *M* 9 earthquake ruptured from Cape Mendocino, California to Vancouver Island, Canada—based on geology, paleotsunami deposits, and Native American oral histories. The date was determined from Japanese documents that described the tsunami impact on Japan. It produced very strong shaking, coastal uplift and subsidence, and a tsunami that affected much of the Pacific Ocean.

April 18, 1906 San Andreas fault – *M* 7.9 earthquake ruptured from Santa Cruz to Cape Mendocino, the largest Northern California earthquake in the past 200 years. Often called the San Francisco earthquake, it caused major damage as far north as Humboldt County and was felt throughout the state.

November 8, 1980 offshore Gorda plate fault – *M* 7.2 earthquake located offshore of Trinidad caused a highway overpass to collapse, and seriously injured six people driving on the bridge. Caused \$2 million in property damage and felt from San Francisco to central Oregon and western Nevada.

April 26-27, 1992 Mendocino triple junction area – *M* 7.2, 6.5, 6.6 earthquakes caused hundreds of injuries, landslides, and major damage to buildings in southern Humboldt County. The second earthquake caused a fire that destroyed Scotia's business district. Coastal uplift of a 10-mile section of coast near the Mattole River produced a small tsunami that was recorded as far away as Hawaii. It was felt from central California to southern Oregon and caused \$66 million in damage.

January 9, 2010 offshore Gorda plate fault – *M* 6.5 centered 30 miles offshore of Eureka. The earthquake caused about \$20 million in damage to structures in Eureka and was felt from south of the San Francisco Bay Area to Eugene, Oregon.

December 20, 2022 Gorda plate fault – *M* 6.4 centered just offshore near Ferndale produced some of the strongest ground motions ever recorded in a California earthquake. Caused \$32 million in damage and felt from Monterey, California to Portland, Oregon.

Types of Earthquakes

Offshore earthquakes

Most of our large earthquakes have been located offshore within the Gorda plate or along the Mendocino fault. Many of these earthquakes have been too far from population centers to cause damage. But some were close enough to the coast to knock down chimneys and damage buildings. For offshore earthquakes of *M* 7 or larger, tsunami alerts may be issued.

Onshore earthquakes

The most damaging Northern California earthquakes in the past century were caused by faults onshore. Earthquakes as small as *M* 5 can cause damage if they are close to populated areas. There are many faults throughout the region that can produce earthquakes in the magnitude 6 to 7 range.

The Big One – the Cascadia subduction zone

The last great earthquake on the Cascadia subduction zone occurred in 1700. It was likely a magnitude 9, rupturing the entire subduction zone from Humboldt County, California to British Columbia, Canada. Geologists have found evidence for at least 13 great Cascadia earthquakes during the past 7,000 years. They occur irregularly at intervals anywhere between 200 and 800 years. The next Cascadia earthquake may be similar to the *M* 9.1 Japan earthquake in 2011. It will be felt from southern California to Canada and inland to Nevada. Shaking could last for minutes. It will also produce a tsunami that may affect not only our coast, but coastal communities in other countries throughout the Pacific basin.

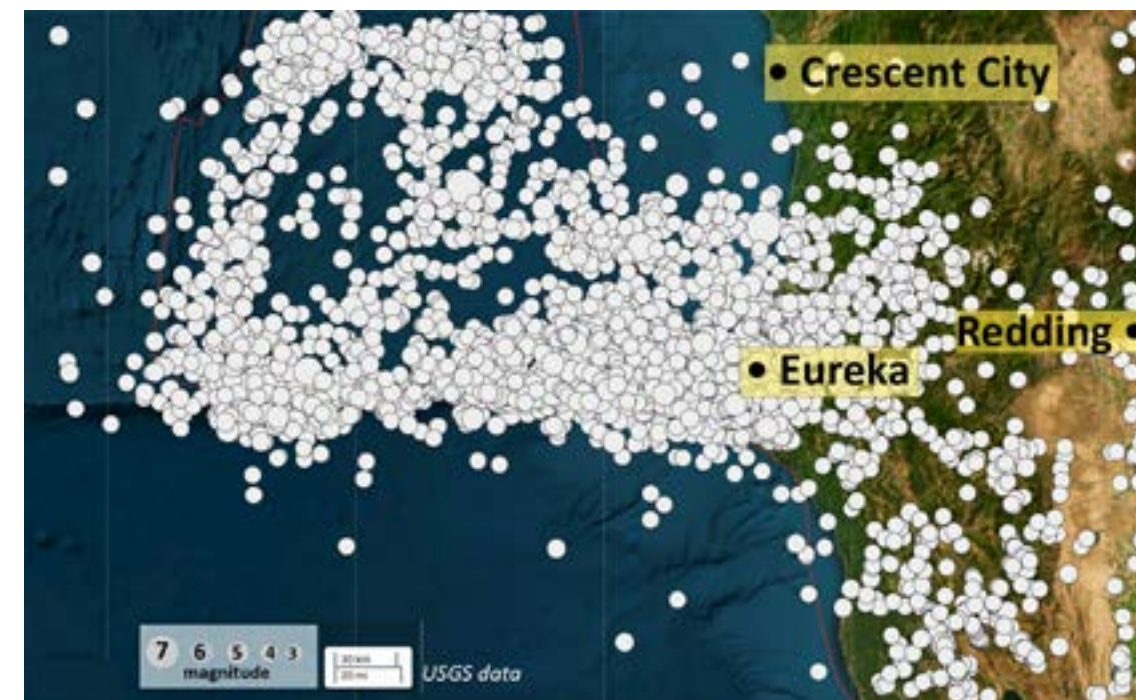

[USGS - current earthquakes](https://www.usgs.gov/monitoring-data/earthquakes)

Northern California earthquakes between 1970 and 2023

Recent Earthquakes Don't Tell the Whole Story

The first seismographs were installed in California just over 100 years ago and written records only go back to the mid-1800s. For evidence of earlier earthquakes, scientists look for geologic clues such as surface fault rupture and tsunami deposits, oral history of native peoples, and written records from distant areas that were affected by a Northern California-generated tsunami. The study of ancient earthquakes is called paleoseismology.



[Orphan tsunami](https://www.orphan-tsunami.com/)

Most Earthquake Damage Is Caused by Shaking

Northern California is earthquake country and will experience earthquakes with strong ground shaking in the future. An area that did not shake strongly in one earthquake may be severely affected in another.

Shaking can cause major damage to poorly built structures. In California, where building codes require earthquake resilience, very few buildings will collapse. Shaking will cause items to topple and fall. Bookshelves, cupboard contents, and other flying objects can injure you.

Cleanup is costly and time consuming. The actions you take now to secure items and strengthen your home will reduce your losses.

Even if your residence escapes damage, downed power lines, damaged roads, and water lines could isolate you at home, at work, or in your car. You may need to evacuate if threatened by tsunami or fire. The first hours and days after an earthquake are more manageable if you have a plan and emergency supplies.

Earthquakes also cause damage in other ways...

Destructive Fires

Fires were the biggest cause of property loss in the 1906 and 1992 earthquakes. Toppled wood stoves and ruptured gas lines make our homes and businesses vulnerable to post-earthquake fires. Disrupted roads and water lines can make firefighting difficult. The 1964 tsunami caused this fire in Crescent City (right) that burned for three days.



Landslides

The steep slopes and unstable rock of Northern California are prone to landslides any time of the year. Shaking can cause landslides that damage and block roads, isolating communities. They can dam rivers and cause a flood hazard when the rivers break through. The Navarro River in this photo was temporarily dammed by a landslide in 1995.

Damaged Infrastructure

Shaking often damages roads and bridges, causing accidents and hindering rescue and relief efforts. Damage to gas and electrical systems can cause fires, as well as major service outages. This Highway 101 overpass south of Eureka collapsed in the 1980 M 7.2 earthquake.



Liquefaction

During shaking, saturated soil may lose strength and flow like a liquid. Liquefied ground may spread and slump disrupting roads and damaging pipes. This photo shows liquefaction-induced bank failures on the Eel River near Ferndale caused by the 1906 earthquake.

Surface Rupture

Shallow faults may break the ground surface and damage buildings, roads, and other structures. Underground pipelines may rupture. This track in Taiwan was deformed when a thrust fault broke in 1999.



[More on how earthquakes cause damage](#)

TSUNAMIS are a deadly side effect of offshore earthquakes. Continue reading to learn more.

What is a TSUNAMI?

A tsunami is a series of water surges usually caused by an earthquake beneath the sea floor. Tsunamis can come from earthquakes nearby or thousands of miles away.



1946 – HAWAII An earthquake in Alaska caused surges at Coconut Island near Hilo that looked like a sloping mountain of water.



2004 – THAILAND The Indian Ocean tsunami looked like a river in flood.



2011 – JAPAN tsunami in Crescent City, strong currents ripped piers apart. It may not look dramatic, but these currents lasted for days and were strong enough to destroy the harbor.

TSUNAMIS ARE TRICKY

- The first surge may arrive in minutes if the source is close or take many hours for earthquakes far away.
- The first surge won't be the largest; successive waves may be spaced irregularly from minutes to an hour or more. Just when you think it is over, a larger surge may arrive.
- Tsunami danger can last 12 hours and sometimes more than a day.
- Tsunamis may appear as a rapidly rising tide, a sloping wall of water, or a chaotic mass of swirling water often choked with debris.
- No two tsunamis are alike.

The biggest tsunamis will come from great earthquakes close by. Feeling the earthquake is your warning to evacuate; **DO NOT** expect an official notification.

Tsunami Facts

- Tsunamis are most commonly caused by earthquakes, but are also triggered by submarine landslides, volcanic eruptions, explosions, and very rarely, meteor impacts.
- Most tsunamis are only inches high in the open ocean, but large tsunamis may reach heights of 20 to 50 feet along the coast and, in isolated areas, even higher.
- Areas at greatest risk are beaches and harbors. Only major tsunamis flood the land and or travel up river channels.
- Sometimes the first sign of a tsunami is drawdown – an unusual lowering of the ocean exposing the sea floor. The water will surge back quickly, much faster than you can run. Not all tsunamis are preceded by a drawdown.



2004 – THAILAND In Phuket, the tsunami began as a withdrawal of the ocean water (drawdown) that exposed hundreds of feet of the sea floor.



2011 – JAPAN An earthquake in Japan caused a tsunami that pulled cars and debris into the water in Kamaishi.

SHAKING IS YOUR WARNING. IF YOU ARE IN A TSUNAMI ZONE, EVACUATE TO HIGH GROUND OR INLAND.

Tsunamis are more common on the North Coast than you may think

Forty-five tsunamis have been recorded in Northern California between 1933 and 2023. Five caused damage. The most damage was caused by a tsunami that came from Alaska after the M 9.2 1964 earthquake. It flooded 29 blocks of Crescent City, and damaged harbors and port facilities as far south as Santa Cruz. The tsunami caused 12 deaths in Northern California.

Feeling an earthquake, especially one that lasts a long time, is the natural warning that a tsunami could be coming. Always take shaking seriously. In a tsunami zone? Evacuate as soon as it is safe to walk. Include a portable radio in your Grab and Go Bag; radio stations will announce if there is no tsunami and it is safe to return home.

NEVER TURN YOUR BACK ON THE OCEAN

Tsunamis are not the only hazard on North Coast beaches. Sneaker waves can catch you unaware at any time of the year.



[Beach safety brochure](#)

Are you a recreational boater or commercial fisherman? Learn more about special considerations for mariners.



[Tsunami tips for mariners](#)

Two Ways to Know if a Tsunami is Coming

Natural Warnings

WHEN THE SOURCE IS CLOSE, ground shaking, ocean roar, or the water receding unusually far are all nature's warnings that a tsunami may be coming. If you observe any of these warning signs, immediately walk to higher ground or inland. Don't wait for official notification. A tsunami may arrive within minutes and damaging surges could continue for 12 hours or longer. Stay away from coastal areas until officials permit you to return.



[Know your tsunami zone](#)

Official Warnings

WHEN THE SOURCE IS FAR AWAY, alerts are issued on cell phones, TV, radio stations, or NOAA weather radios. Move away from the beach and tune into local radio or television stations for more information. Follow the directions of emergency personnel who may ask you to evacuate low-lying coastal areas.

All California counties provide emergency notification systems on phones, cell phones, email and texts, but you must sign up in advance to get alerts. Contact your county to sign up.

Official Warnings from Tsunami Warning Centers

The National Tsunami Warning Center monitors events around the Pacific that might produce a damaging tsunami on the Northern California coast. Bulletins are issued in five minutes or less following West Coast or Alaska earthquakes and within ten minutes after far away earthquakes.

Two types of alerts may require action:

- **Tsunami Warning:** On land flooding and powerful currents possible. **If you hear that a Warning has been issued, leave the beach or harbor and get more information.** Local officials will let you know what areas need to be evacuated.
- **Tsunami Advisory:** Flooding of dry land not expected, but beaches, harbors, and low-lying coastal areas may be damaged by strong currents. Officials may request you leave those areas.

A **Tsunami Watch** may be issued when there is time to assess the threat and there is a chance a Warning or Advisory could be issued. Wait for further guidance from officials.

Official warnings are for tsunamis coming from far away. Our largest tsunami threat is from the Cascadia subduction zone. Feeling the ground shake is likely your only warning. Know what areas are hazardous and immediately head to high ground or inland away from the coast if you are in a tsunami zone.

Tsunami alert terminology may change in the future. Information in this magazine is current as of 2023. Check with NOAA's tsunami program for updates.



[Tsunami alerts](#)

How Do I Know if a Felt Earthquake is Big Enough to Cause a Tsunami?

- If you are on the beach and feel an earthquake, move inland or to high ground immediately.
- If you feel an earthquake that lasts a few seconds, it wasn't large enough to cause a tsunami. If it lasts for a very long time, even if the shaking isn't strong, evacuate as soon as you can safely move.
- **GO ON FOOT.** Roads and bridges may be damaged by strong ground shaking. Avoid downed power lines.

If evacuation is impossible, go to the upper floor of a sturdy building or climb a tree—but only as a last resort.

NOT SURE WHAT TO DO? When in Doubt, Drill it Out
Every earthquake is an opportunity to practice your evacuation skills.

[Is the shaking long enough?](#)



Tsunami Maps

The California Geological Survey (CGS) has mapped California's Tsunami Hazard Areas. Find out your tsunami risk at the 'Know Your Tsunami Zone' QR code on page 14. Contact your county Office of Emergency Services for more information about your area. This map is an example from Humboldt County.

California's tsunami maps are based on the worst case for each area. On the North Coast, the largest tsunami is the result of a M 9 earthquake on the Cascadia subduction zone.

What if I am Outside the Map Area?

Go to an area 100 feet above sea level or two miles inland, away from the coast. If you cannot get this far, go as high and as far as possible. Every foot inland or upwards will make a difference.

DON'T GO TO THE COAST!
You will put yourself in danger and make it more difficult for the people who need to evacuate.



NATURAL AND OFFICIAL WARNINGS ARE EQUALLY IMPORTANT. RESPOND TO WHICHEVER YOU HEAR OR OBSERVE FIRST!

Lessons from Recent Tsunamis

2004 Indian Ocean Tsunami

The M 9.2 earthquake produced a tsunami that damaged 14 countries and killed 227,000 people in the Indian Ocean region. The first surges arrived at an island near the epicenter in less than ten minutes after the earthquake. Two hours later, Sri Lanka and Thailand were struck. It was still large enough to damage the east coast of Africa seven hours after the earthquake. Few people knew about tsunamis and there was no Indian Ocean tsunami warning system in 2004 to warn populations far from the source region of the impending waves.



[Indian Ocean tsunami animation](#)

Lessons from the Simeulue Islanders

Langi is a village on Simeulue Island off the coast of Sumatra. The 2004 earthquake damaged many buildings in the town and the first tsunami surge arrived only eight minutes after the earthquake shaking began. Some tsunami surges were 45 feet high. Every building in the town was destroyed.

Not a single man, woman or child in Langi was killed.

Why no casualties? Langi has little contact with the wider world. Elders pass the stories of earthquakes and tsunamis to their children and grandchildren. If the ground shakes, everyone knows what to do. Adults grab children and wheel those unable to walk to high ground in garden carts. The last major tsunami occurred in 1907, over five generations ago. Earthquakes are frequent in Indonesia and few cause tsunamis. But Simeulue Islanders consider every earthquake an opportunity to practice their evacuation skills. In 2004, their vigilance paid off.



2004 - SUMATRA (Above) Langi Village was completely destroyed by the 2004 tsunami. (Below) Four months later, a new house has been built on the damaged foundation.



2022 Tonga Volcanic Explosion

On January 15, an eruption in the Tonga Islands produced the largest explosion ever recorded with modern instruments. The blast propelled materials 36 miles above the earth's surface, above the stratosphere. The explosion was heard in Alaska and sensitive instruments tracked the pressure pulse in the air traveling around the planet at least four times.

Tsunamis caused by deformation of the seafloor are well understood. The tsunami speed depends only on the depth of the ocean, traveling outwards at roughly the speed of a jet plane. But after the Tonga eruption, the first waves arrived more quickly. The culprit was the pressure wave in the atmosphere traveling at the speed of sound, deforming the ocean waters below. It even hopped over land masses, producing small tsunami signals in the Caribbean and Mediterranean.

There was a conventional tsunami as well. The eruption deformed the sea floor, triggering a second tsunami pulse that arrived after the pressure wave tsunami. Both of these tsunamis were recorded by tide gauges on the North Coast.

The Tonga tsunami was not catastrophic. Injuries were reported in California where people did not heed beach

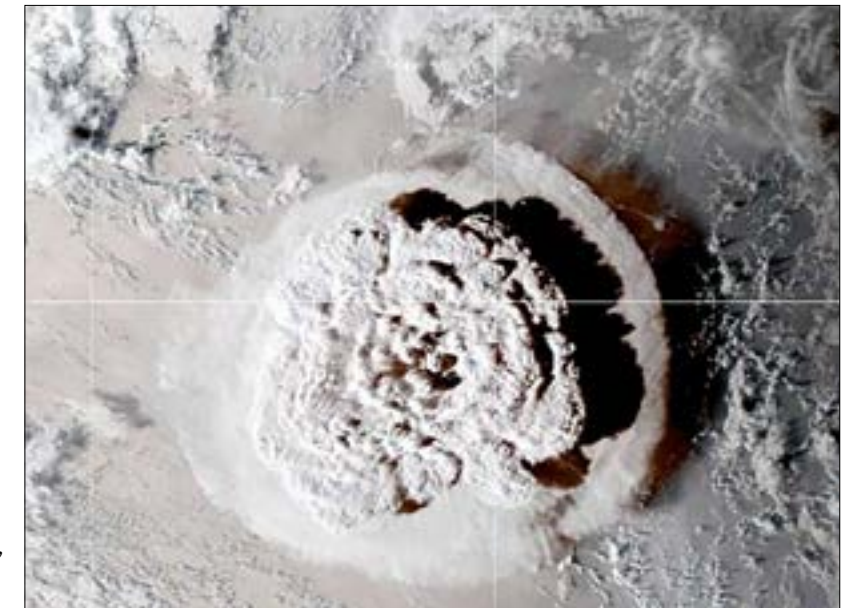

The Tonga eruption as seen from space.

closures. Tsunami warning protocols have been updated to include volcanic explosions and the resulting pressure wave tsunamis.

Tsunami science is young. Large tsunamis occur infrequently and there is still much to learn about what causes them and how they impact coasts.

The tsunami traveled across the Pacific reaching the US West Coast in nine hours. It arrived at low tide and produced little flooding on land, but strong currents tore up docks, harbor structures, and smashed boats. The cost to repair the damage exceeded \$100 million.

- All of the damage was caused by strong currents.
- Surges continued for five days in Crescent City's harbor! The highest water occurred 18 hours after the first wave when the tide was high enough to boost the tsunami surge and flood a few low areas.



All the damage to Crescent City' Harbor's small boat basin was caused by strong currents and occurred more than two hours after the first tsunami wave arrived.

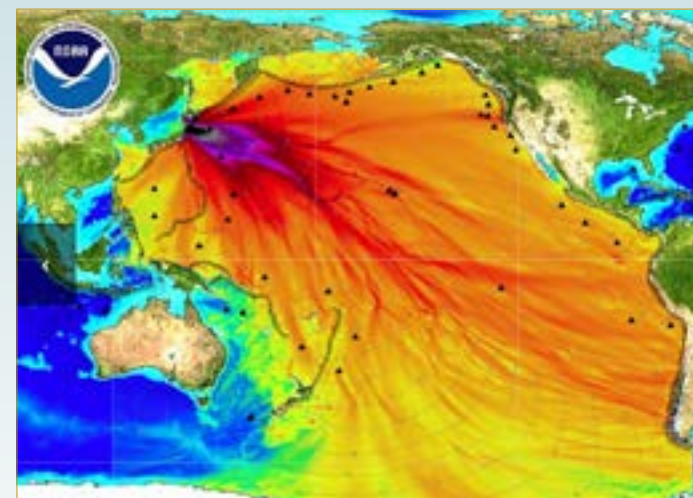

Modeled ocean water heights from the 2011 tsunami. (Purple and red show the highest water). The shape of the sea floor funnels some of the energy at California's North Coast.

2011 Japan

On March 11, a M 9.1 earthquake occurred in Japan. Rigorous building codes resulted in few damaged structures. Japan is the most tsunami-aware country in the world. 95% of people evacuated hazardous areas.

Unfortunately, the tsunami was larger than expected and at least 18,000 people died.

Several factors contributed to the loss of life:

- Elderly people with no way to evacuate.
- People in cars were stuck in massive traffic jams.
- Delaying a few minutes to gather belongings caused people to be trapped.

Earthquake Basics

Earthquakes occur when rocks deep underground break along a zone of weakness (fault, see page 6). In California, most earthquakes are between 3 to 20 miles below the surface and the fault is hidden. Only very large earthquakes produce fault ruptures that can be seen on the ground.

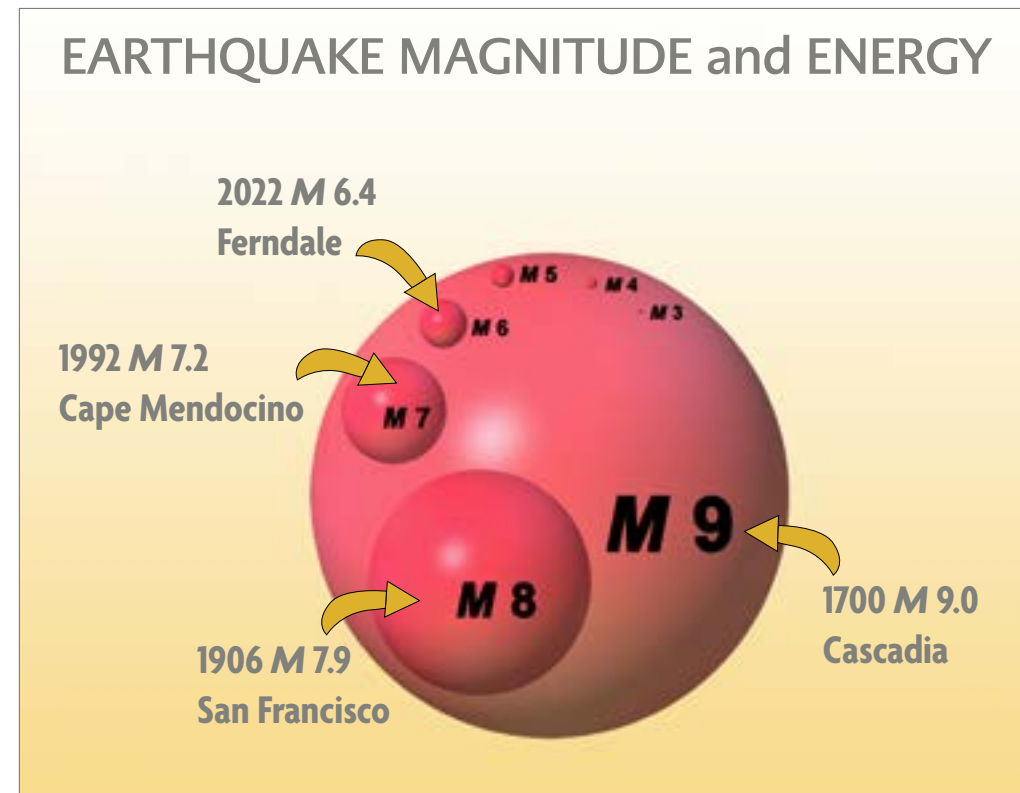

HOW BIG IS BIG?

Magnitude (M) is related to how much energy is released in an earthquake, but the scale is not linear. A M 7 releases 32 times more energy than a M 6, and about 1000 times more than M 5.

A M 4 will be felt only close to the epicenter and will last a few seconds. A M 7 could be felt by people hundreds of miles away and last 20 seconds or longer.

Foreshocks, mainshocks, and aftershocks are all earthquakes in their own right and can cause damage if large enough. Aftershocks can make buildings weakened by the mainshock collapse and sometimes cause more damage than the larger earthquake.

How To Tell Whether An Earthquake Is An Aftershock Or Not?

They often cluster near the ends of the rupture area where stress has been increased by fault movement. Aftershocks are over when the regional seismicity returns to background levels before the earthquake. Some aftershocks occur on nearby faults, triggered by stress changes produced by the mainshock.

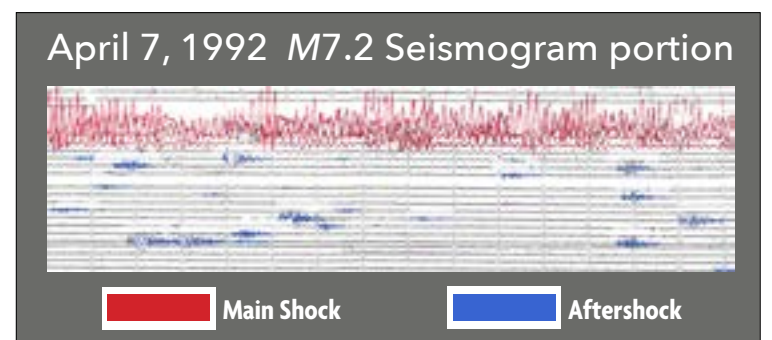

[Visualizing foreshocks and aftershocks](#)

Earthquake and Tsunami Misconceptions

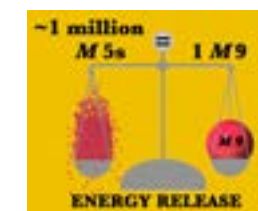

Small Earthquakes Prevent Big Ones from Happening

Small earthquakes release very little energy compared to large ones. It would take roughly five M 5 earthquakes every day for

500 years to equal the power of one M 9.

long ago. The 1992 Cape Mendocino earthquake uplifted a 10-mile stretch of coast about four feet. Landslides may occur on coastal bluffs or steep cliffs during earthquakes, but otherwise, California is firmly anchored.

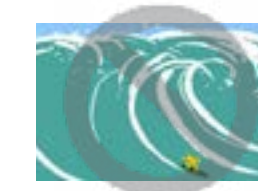

A Tsunami is a Surfer's Ultimate Big Wave

TSUNAMIS ARE NOT SURFABLE. Surfers know how little control they have when their board is in

whitewater. A tsunami has no wave face for a surfboard to grip and the water is often filled with debris.



Stand in Doorways During Earthquakes

All parts of modern structures are strong enough to resist collapse. Moving to a doorway during

shaking exposes you to falling debris. You may be crushed by others exiting or battered by a swinging door. It is safer to Drop, Cover, and Hold On during an earthquake.

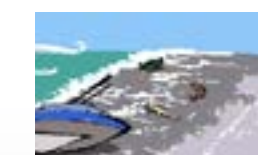

The Ocean Always Recedes Before Tsunami Waves Arrive

Sometimes the ocean recedes (drawdown), exposing sea floor

before tsunami waves flood land – BUT NOT ALWAYS. Whether the first tsunami surge is a drawdown or a positive surge depends on the source and where you are. Any unusual change in the ocean such as the water lowering, a sudden increase in wave activity, or a louder than usual roar is a sign to get to high ground. If you feel an earthquake on the beach, don't wait for the drawdown before evacuating. There might not be one!



California Will Fall into the Ocean

Despite Hollywood's special effects, California will not fall into the ocean. Earthquakes help keep

the land above sea level. Without uplift from earthquakes, all of the continental land masses would have eroded to sea level



[Recording of the 1964 Alaska earthquake](#)

Intensity is a measure of how strongly the ground shakes at a particular location. Intensity always varies with the largest values closer to the epicenter and lower ones farther away. Intensity can be measured from instruments, or estimated from damage surveys, and USGS "Did You Feel It?" reports.

Magnitude and intensity are not the same thing!

Some moderate earthquakes may feel stronger than larger magnitude ones. Shaking strength (Intensity) is a function of distance from the source, local and regional geology, and rupture characteristics. But larger magnitude earthquakes always last longer. A M 6 is typically over in ten seconds or less; shaking from a M 9 will last for minutes.



[Feel an earthquake? Report your observations here.](#)

Foreshocks, Mainshocks, and Aftershocks

Earthquakes almost always occur in sequences. The largest earthquake in the sequence is the **mainshock**. Some earthquakes are preceded by smaller earthquakes (**foreshocks**). All large earthquakes are followed by **aftershocks**. They are most frequent in the first hours and days after the mainshock. For very large earthquakes, aftershocks may continue for years.

Rumors are rampant after earthquakes and tsunamis. Check with a credible source such as the USGS, NOAA, or CGS before passing on something you may have heard.

Seven Steps That May Save Your Life

EARTHQUAKES AND TSUNAMIS are inevitable, but damage and injuries can be reduced even in the largest earthquakes. California has developed seven steps to keep you and your loved ones safe, reduce injuries and property damage, and recover quickly. The same steps can be followed in schools, businesses, and other places. Taking the time to prepare will give you the peace of mind that you and your family will know what to do when the next earthquake occurs.

Preparation is the key to surviving a disaster. Start by talking to your family, friends, neighbors, and co-workers. Prioritize your highest needs and plan the next steps.

Many people are overwhelmed by the prospect of a natural disaster and don't prepare at all. Make a habit of talking about preparedness and take it one step at a time.

Start Here!

PREPARE

1. Know Your Tsunami Zone – Secure Your Space [see illustration below and page 22](#)
2. Plan to be Safe [\(page 24\)](#)
3. Organize Disaster Supplies [\(page 25\)](#)
4. Minimize Financial Hardships [\(page 26\)](#)

SURVIVE

5. What to Do When the Ground Shakes [\(page 28\)](#)
6. When the Shaking Stops [\(page 30\)](#)

RECOVER

7. Reconnect and Restore [\(page 31\)](#)

Make Your Home Earthquake Safe

Connect these actions with their locations in the house below.

STEP 1—SECURE YOUR SPACE

- 1 Know whether you live, work or play in a tsunami hazard zone.
- 2 Hang plants in lightweight pots with closed hooks, well secured to a joist or stud, away from sleeping areas.
- 3 Store fire extinguisher (type ABC) in easily accessible location. Know how to use it.
- 4 Install latches on kitchen cabinets.
- 5 Use flexible connections where gas lines meet appliances.
- 6 Remove or lock refrigerator wheels, secure to studs.
- 7 Keep several flashlights in easily accessible places around the house.
- 8 Secure valuable electronics such as computers and televisions.
- 9 Keep breakables in low cabinets or secure cabinets with latches.
- 10 Move heavy plants and other large items to floor or low shelves.

- 11 Hang mirrors and pictures on closed hooks.

- 12 Secure free-standing woodstove or fireplace insert.

- 13 Keep heavy unstable objects away from doors and exit routes.

- 14 Place bed away from windows or items that may fall.

- 15 Secure knickknacks and other small valuables with museum putty.

- 16 Brace overhead light fixtures.

- 17 Place only lightweight/soft items over bed.

- 18 Secure top-heavy furniture to studs.

- 19 Keep wrench or turn-off tool in water proof wrap near gas meter.

- 20 Know the location of your main electrical switch (fuse box or circuit breaker).

- 21 Secure water heater with metal straps attached to studs.

- 22 Trim hazardous tree limbs.

STEP 2—PLAN TO BE SAFE

- 23 Have your emergency plan accessible and discuss with all family members.

STEP 3—ORGANIZE DISASTER SUPPLIES

- 24 Have a portable radio and batteries easily accessible.
- 25 Keep an emergency backpack with copies of important documents near the door to grab and go.
- 26 Keep flashlight, slippers, and gloves next to beds.
- 27 Keep gas tank and or electric charge at least half full.
- 28 Store emergency food and water supplies in a dry accessible area. Include first aid kit, extra cash, portable radio, extra batteries, medications, and other necessary supplies.

STEP 4—MINIMIZE FINANCIAL HARDSHIP

- 29 Use anchor bolts every 4 to 6 feet to secure home to foundation.
- 30 Reinforce brick walls and chimneys.

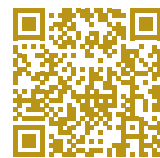

[Preparedness resources](#)

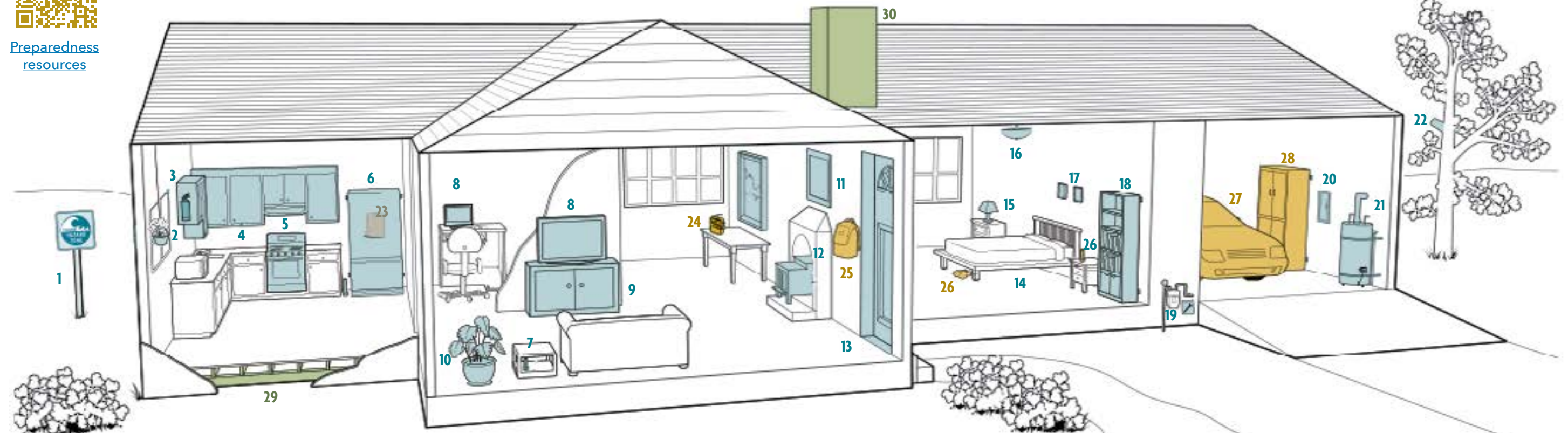

Step 1

KNOW YOUR TSUNAMI ZONE



Find out if you live, work, or visit in a tsunami zone. Look for the **ENTERING** and **LEAVING** Tsunami Zone signs on coastal roads and highways in your area. Go online, visit your county Office of Emergency Services or regional National Weather Service Forecast Office for tsunami maps and brochures.

SECURE YOUR SPACE

HANGING OBJECTS

- Remove or secure hanging plants and heavy objects where people sleep, sit, or spend time.
- Hang mirrors and pictures on closed hooks (A).
- Brace overhead light fixtures.

KITCHENS

- Install latches on cabinet doors. Avoid magnetic latches. They will open during strong shaking (B).
- Add lips to open shelving to prevent breakable items from falling (C).
- Secure refrigerators and major appliances.

Use caution and a flashlight when entering kitchens after earthquakes. Broken glass, liquids, and fallen items on the floor will make them hazardous.

FURNITURE

- Store heavy and breakable items on lower shelves.
- Secure tall furniture to wall studs with lag bolts (D).
- Secure dressers, cribs, and infant furniture to wall studs.

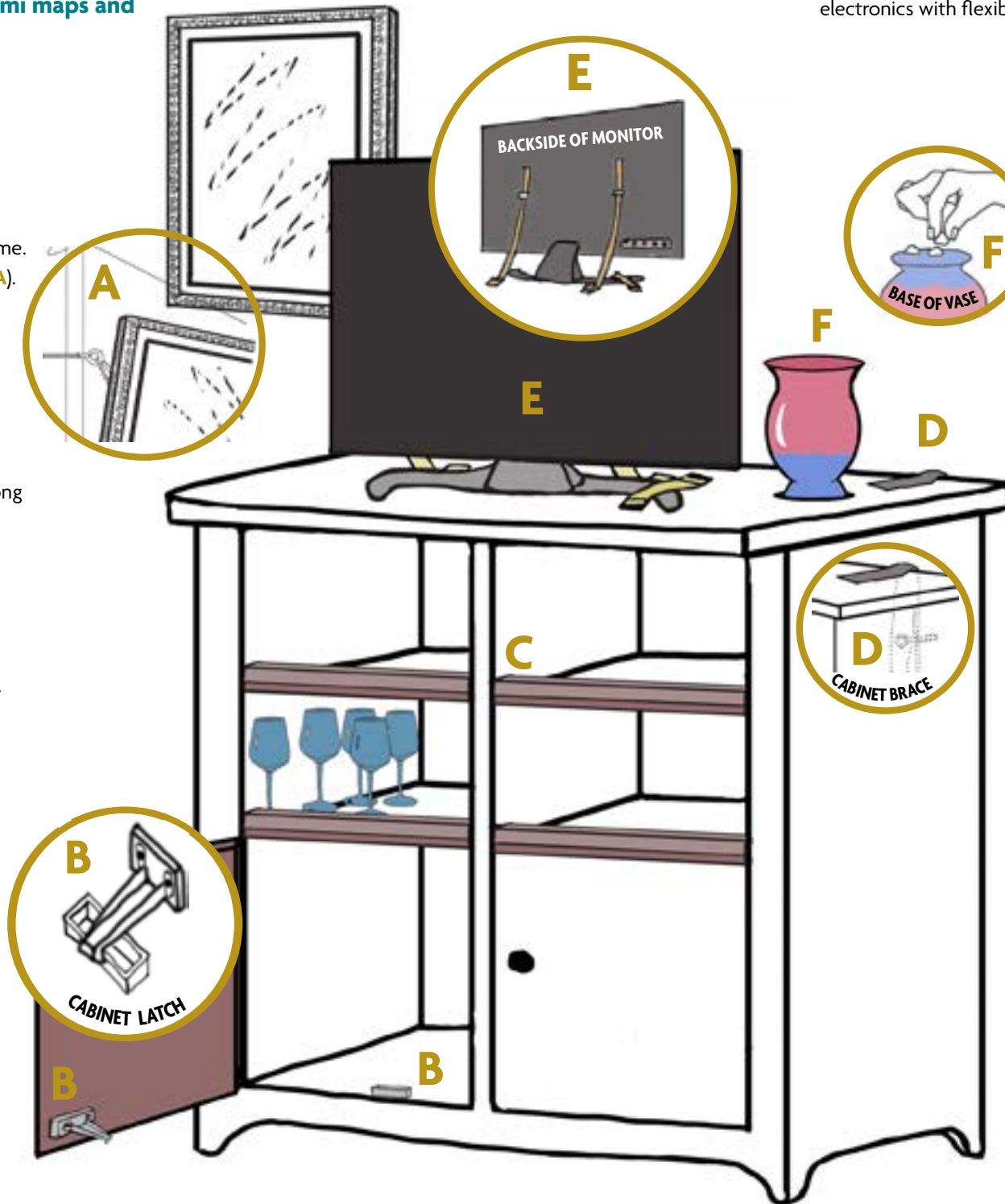

GARAGES AND UTILITY ROOMS

- Move flammable or hazardous materials to low cabinets that are securely latched.
- Secure stored items so they won't fall and block access to doors and vehicles.
- Know how to manually open your garage door.

HOME AND OFFICE ELECTRONICS

Secure televisions, computers, sound systems, and other electronics with flexible nylon straps and buckles (E).

OBJECTS ON OPEN SHELVES AND TABLETOPS

- Hold small valuables in place with removable putty, museum wax, or quake gel (F).
- Add lips to open shelving to prevent breakable items from falling (C).
- Move heavy objects and breakables to lower shelves.

ABOVE GROUND PROPANE TANKS

Mount tanks on a concrete pad and bolt legs to the pad.

WATER AND GAS PIPES

- Evaluate, replace, and properly secure rusted or worn pipes.
- Replace rigid gas connections with flexible stainless steel connections.

Feel overwhelmed?

Don't do everything all at once. Make a list of your priorities and take one or two at a time.

Additional information, including how-to instructions, is available at your local American Red Cross, Office of Emergency Services, or National Weather Service Forecast office.

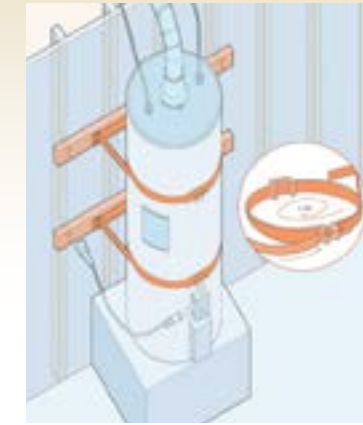

WATER HEATERS

- Anchor to wall studs or masonry with metal straps and lag screws.
- Install flexible water connectors

WOOD STOVES

Wood stoves are heavy and likely to topple or pull away from walls during strong shaking.

- Anchor stove feet by bolting to the floor or creating brick and mortar bracing to keep stove from sliding. Anchors must not conduct heat.
- Brace stove pipes (G).
- Keep fire extinguishers handy and know how to use them.

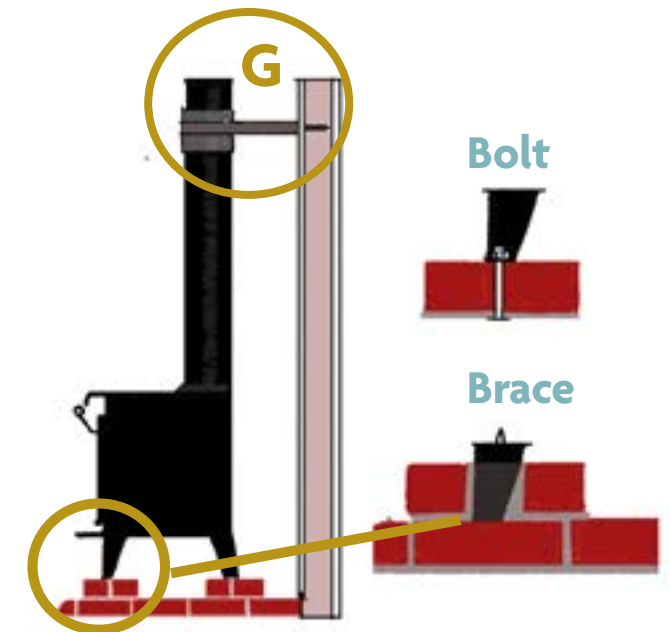

Bolt

Brace



[Making your home earthquake safe](#)

Step 2 PLAN TO BE SAFE

HAVING THE TALK

1. Get family or office together



2. Identify Your Situation

Who has special needs? Do you have pets or livestock? Do you live in a tsunami zone?

Name _____
 Address _____
 Email/Phone _____
 Doctor/Medical Insurance _____
 Medications _____
 Medical Devices _____
 Dietary Restrictions _____
 Out of the Area Contact _____
 Meeting Place _____
 Children: School _____
 Childcare Provider _____
 Other _____

3. Discuss Your Plan of Action

- Break it down into pieces such as
- put together emergency supplies
 - fill out personal emergency plans
 - what to do when the shaking starts

4. How Will You Communicate After the Earthquake?

Stay off your phone unless you have a life-threatening emergency. Select an out-of-the-area contact person to relay messages. Keep a hard copy of important phone numbers with you. Cell phones and internet are unlikely to work.

5. Assessing Damages Afterwards

If your home is damaged, talk about where you will take shelter outside of your home. Plan to document losses by taking photos or videos inside and outside of your residence.

YOU NOW HAVE A PLAN! Make sure everyone in your house has a copy and save it on your phone.

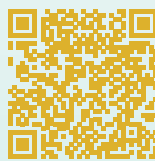

[Detailed Emergency Plan Template](#)

Traveling? Let someone know your travel plans. Include where you will be going and when you plan to return. Learn about any potential hazards in the area you are visiting.

Step 3 ORGANIZE DISASTER SUPPLIES



EMERGENCY SUPPLIES

in your home, workplace, or car will make the difference in your health and comfort if you are isolated for days or weeks. Every household member needs a Grab and Go Bag with essential items for quick evacuation.

Store disaster supplies in a place you can access even if your home is damaged. Consider special provisions such as infant and pet supplies.

NO CABINET? Large trash cans are an inexpensive option for storing emergency supplies.

Safely store supplies for outdoor cooking such as grill, stove, propane tank.

[Emergency kit checklists](#)



GRAB AND GO BAG

Pack essential items in backpacks or small duffle bags for everyone in your house. Place where you can easily grab it if you must leave your home, school, and office quickly. It may be days before you can return to your home.

Include documents like utility bills as proof of residence and photographs of family members and pets.

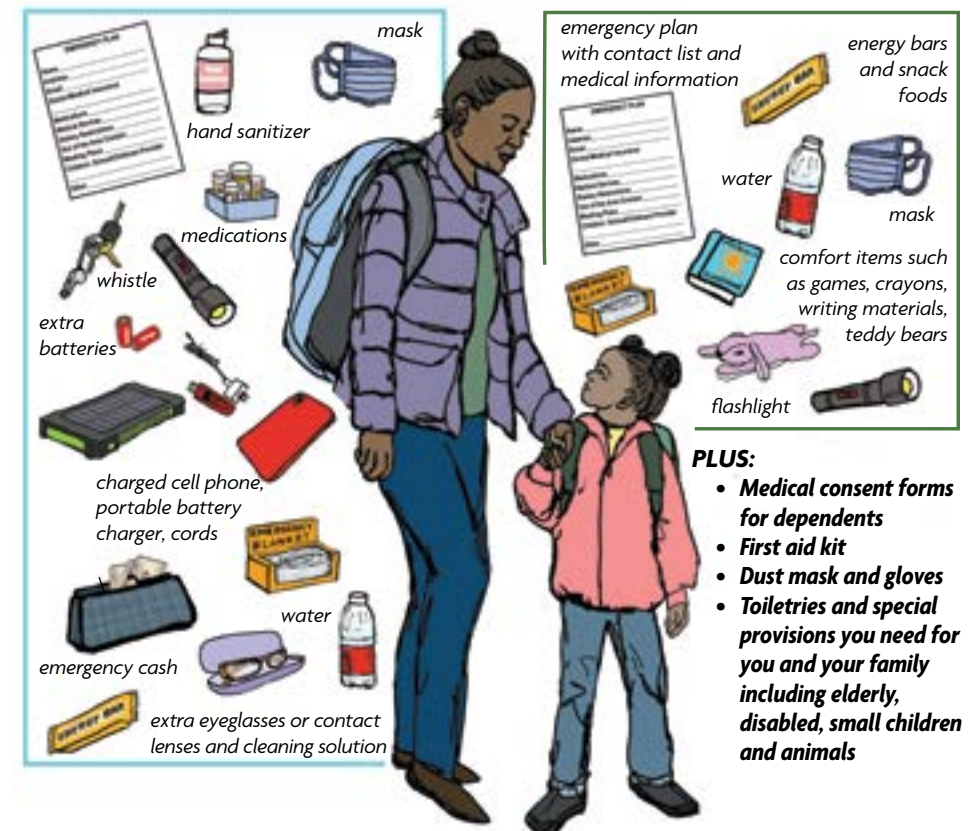

- PLUS:**
- Medical consent forms for dependents
 - First aid kit
 - Dust mask and gloves
 - Toiletries and special provisions you need for you and your family including elderly, disabled, small children and animals

Step 4 MINIMIZE FINANCIAL HARDSHIP

EARTHQUAKES and other disasters are costly. Minimize losses by strengthening your home, organizing important documents, and making electronic backup copies.

Consider your home's resilience to earthquake shaking. Earthquakes shake a building in all directions—up and down, but most of all, from side to side.

SOFT STORIES Large openings in the lower floor, such as a garage door or a house built on stilts make a building vulnerable. Consult a professional to determine if your building is adequately braced.

BRICK CHIMNEYS Many older buildings have unreinforced brick chimneys. If your house has a brick chimney, consult a professional to determine if it is safe.

IF YOU LIVE IN A MOBILE HOME Mobile homes can easily slide off their foundations if not properly secured to resist side-to-side motion. Look under your home—if you only see a metal or wood “skirt” on the outside with concrete blocks or steel tripods/jacks supporting your home, you need to have an “earthquake-resistant bracing system” (ERBS) installed.



[Earthquake Resistant Bracing System for mobile homes](#)

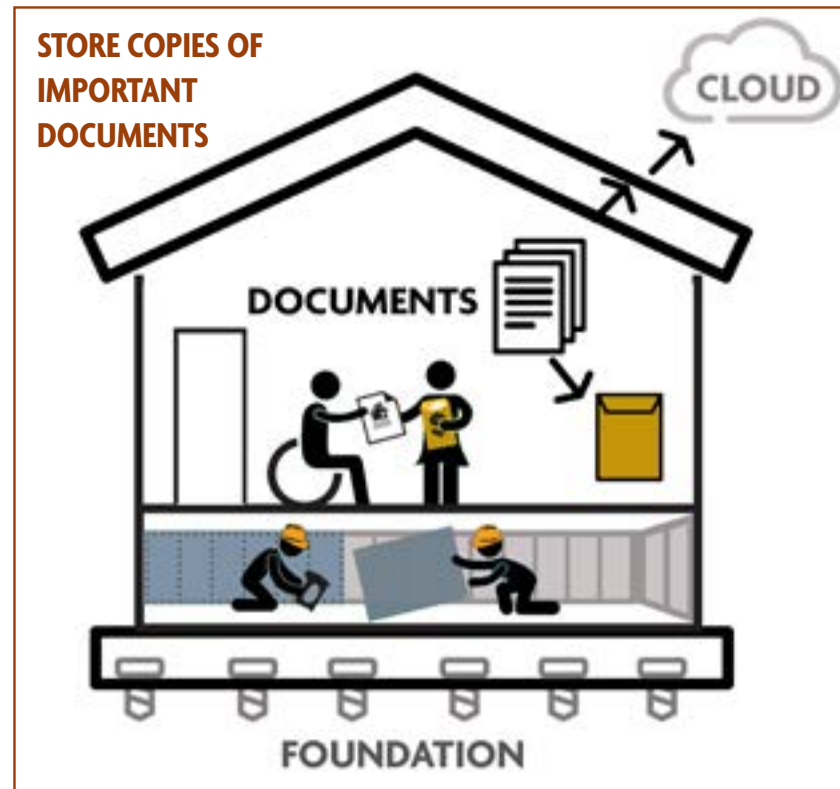

IF YOU RENT

As a renter, you don't control the structural integrity of your building, but you can consider earthquake resilience in choosing a place to rent. When looking for housing, remember:

- Apartment buildings have to meet the same codes and structural requirements as houses.
- Avoid rental units made of unreinforced masonry or those with “tuck-under” parking spaces on the ground floor.
- Consider the safety of attached structures such as stairways and balconies which can be damaged during an earthquake.
- Is the apartment or house in a tsunami zone? If so, is there access to high ground nearby?

Ask your landlord these questions:

- How old is the building? Structures built after 1980 will likely be less vulnerable to foundation damage during earthquakes.
- Is the water heater strapped to the wall studs?
- Can you secure furniture to the walls?



Common building problems and how to fix them:

INADEQUATE FOUNDATIONS Check your house's foundation. The house frame should be bolted to the foundation. Bolts should be no more than six feet apart in a single story and four feet apart in a multi-story building.

UNBRACED CRIPPLE WALLS Homes with a crawl space should have panels of plywood connecting the short “cripple” walls.

WAYS TO PROTECT YOURSELF FINANCIALLY

IMPORTANT DOCUMENTS

These include property deeds, insurance policies, vehicle titles, wills, bank accounts and stocks and bonds, credit cards, and personal information such as passports, driver's licenses, and marriage/birth certificates. Keep electronic records by scanning or photographing documents. Store copies in multiple places and the cloud. Include photographs of your family members and pets.

HOME INVENTORY

Take photos or a video of the interior and exterior of your home and your personal belongings before a disaster occurs as an inventory for insurance purposes or in applying for disaster assistance.

CONSIDER INSURANCE

Most home insurance policies do not cover earthquake or tsunami damage. See page 34 for information on Earthquake and Flood Insurance.

EARTHQUAKE BRACE AND BOLT

Many older homes in Northern California have weak cripple walls, or “pier and post” foundations. These foundations may partially collapse during shaking causing major damage. Reinforcing cripple walls and replacing pier and post foundations with a continuous perimeter is the best option.

Retrofitting older homes to resist shaking can be expensive. California began a program in 2013 to assist homeowners in strengthening the foundations of older homes. Earthquake Brace + Bolt is administered by the California Earthquake Authority (CEA) and provides up to \$3000 to secure and reinforce foundations.

House bolted to foundation



[Brace and Bolt Grants](#)

Step 5 WHAT TO DO WHEN THE GROUND SHAKES OR YOU GET A SHAKE ALERT

STAY IN ONE PLACE - DO NOT GO OUTSIDE WHILE THE GROUND IS SHAKING!

Most injuries in California earthquakes are caused by people moving while the ground is shaking. Every step increases the odds that you will trip or something will fall on you.

INDOORS:



DROP, COVER, AND HOLD ON

- DROP down to the floor where you are. IF a sturdy desk or table is nearby, slide under it.
- HOLD ON to a table or desk and move with it. Stay there until shaking stops.



NO TABLE OR DESK

- Slide away from windows or anything that could topple on you.
- Crouch and make yourself as small as possible. Protect your head and neck with your arms.



LIMITED MOBILITY

- Remain sitting where you are, bracing yourself in place.
- Lean over if you can and protect the back of your neck with your arm..



IN BED

Stay there. Cover your head and neck with a pillow.



IN A STORE

- Drop down to the ground. IF a counter or support is nearby, slide next to it.
- A shopping cart may provide protection from falling items.



THEATER OR LECTURE HALL

Stay seated. Bend over. Protect your head and neck with your arms. AFTER the shaking stops, exit slowly.

OTHER SITUATIONS – always take a moment to be aware of your surroundings.

- **Multi-story building.** DROP, COVER, and HOLD ON. Do not use elevators. Sprinkler systems or fire alarms may activate.
- **Outdoors.** Move away from power lines, trees, signs, and buildings if you can do so safely. Sit on the ground.
- **Driving.** A large earthquake feels like a flat tire. Pull to the side of the road, stop, and set brake. Avoid overpasses, bridges, and power lines. Stay inside the vehicle until the shaking is over.

[What to do when the ground shakes](#)

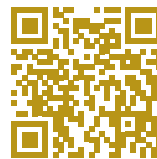

PRACTICE WHAT TO DO IN AN EARTHQUAKE IN THE GREAT SHAKEOUT DRILL

[Shakeout](#)



IN A TSUNAMI ZONE? Shaking is your warning that a tsunami may soon follow. Head to high ground or inland as soon as you can safely walk.



The ShakeAlert® System detects, analyzes, and disseminates information to give you a few seconds to DROP, COVER, and HOLD ON and safely ride out the strongest shaking.

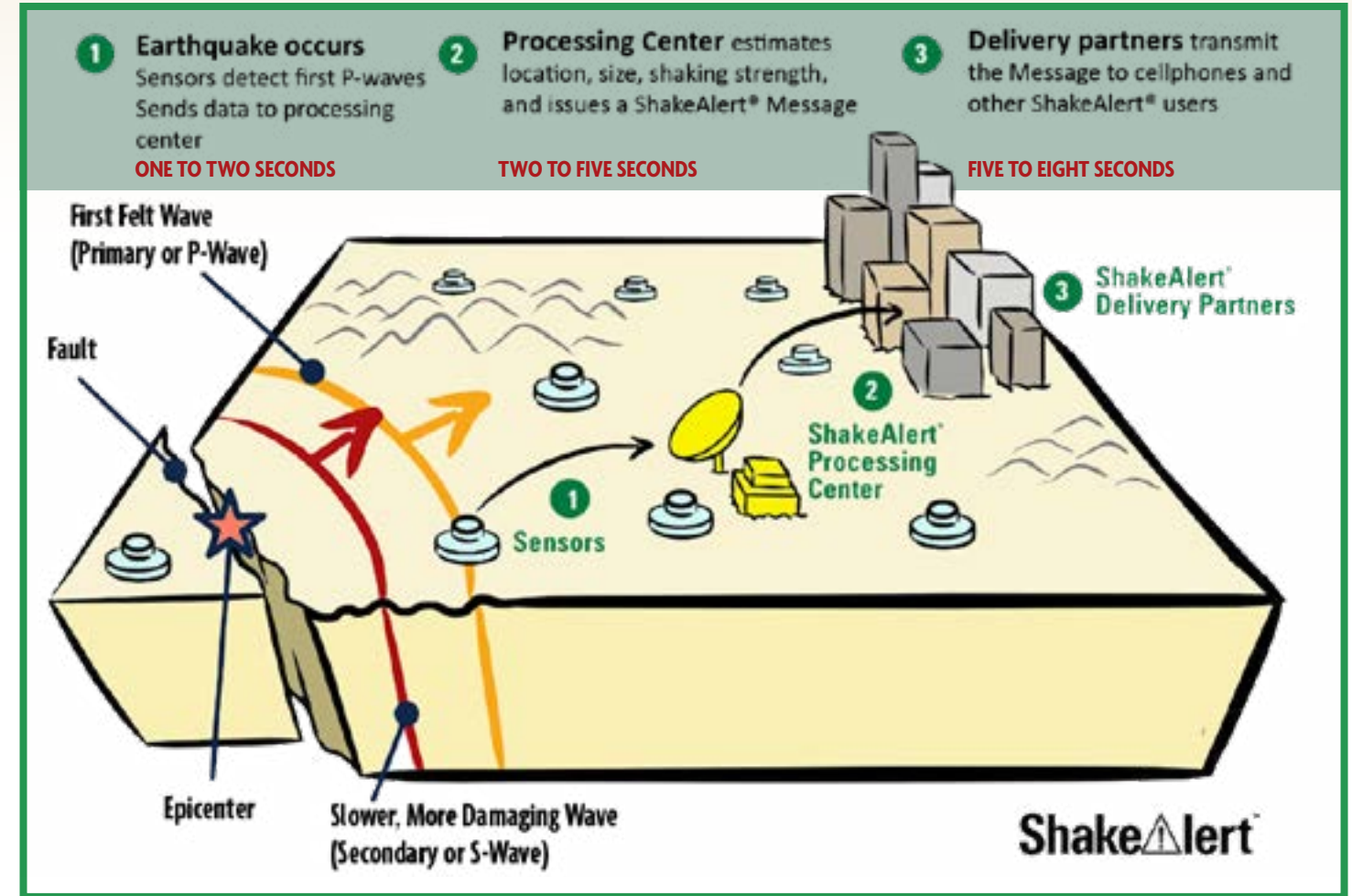

Earthquake early warning in California is powered by the ShakeAlert System, developed by the U.S. Geological Survey and universities. **ShakeAlert does not predict earthquakes.** It relies on automated technology to detect an earthquake after rupture begins and provides the messages for delivery to cell phones and other ShakeAlert users in the area where the earthquake is likely to be felt.

Not everyone will get the notification before the shaking starts. If you are within 10 or 15 miles of the epicenter, the notice will arrive during or after the shaking.

Here are two ways to receive the ShakeAlert-powered messages:

- **MyShake App:** Available for free download on Android or iPhone from your App store. Alerts are delivered to people likely to feel moderate shaking from earthquakes of M 4.5 or larger.
- **Wireless Emergency Alert (WEA):** Automatically sent to all cell

phones in the moderate or stronger shaking area for M 5.0 and larger earthquakes. No App is required, but make sure your phone can receive emergency alerts.

The message on your phone will be brief – “Earthquake Detected! Drop, Cover, Hold On. Protect Yourself.” Use the alert to drop to the ground, stay there, and follow the recommendations on the opposite page. If driving, slow down and find a safe place to park until the shaking stops.

The ShakeAlert System is still under development. It currently provides alerts in the three Pacific States but could someday cover other areas of the United States.

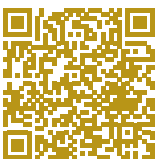

[How to get ShakeAlert](#)

Step 6 WHEN THE SHAKING STOPS TAKE ACTION QUICKLY AND SAFELY

IN A TSUNAMI ZONE – EVACUATE NOW!!

Ground shaking is your tsunami warning. Every second counts - gather your family, your Grab and Go Bag, walk to high ground, and stay there. See page 15, Tsunami Maps, for more information.

HOW DO I KNOW IF A FELT EARTHQUAKE IS BIG ENOUGH TO CAUSE A TSUNAMI?

Not sure? **When in Doubt, Drill it Out.** Every earthquake is an opportunity to practice evacuation.

- GO BY FOOT Roads may be damaged by the earthquake or jammed with traffic.
- AVOID DOWNED POWER LINES or objects in contact with them.



- IF EVACUATION IS IMPOSSIBLE, go to the top floor of a sturdy building or climb a tree but only as a last resort.
- STAY AWAY FROM THE COAST until officials tell you it is safe to return. The hazard may last for hours or days.

[How to tell if the shaking is long enough](#)



NOT IN A TSUNAMI ZONE – STAY WHERE YOU ARE

Most homes and businesses are not in a tsunami zone. Evacuating may put you at risk. Shelter in your home unless you suspect structural damage or other hazards like fire. Consult a professional if you are unsure of the safety of your home.

SITUATIONAL AWARENESS means being aware of your surroundings. Be cautious while you identify hazards. Wear sturdy shoes, work gloves, dust mask, and eye protection.

If you are trapped, protect mouth, nose, and eyes. Use a whistle, cell phone, or tap on walls so rescuers can locate you. Shouting will wear you out.

EXPECT AFTERSHOCKS Some may be large enough to cause additional damage.

Help the Injured

- Treat yourself first then help those around you.
- Use direct pressure to control BLEEDING.
- Administer RESCUE BREATHING and or CPR if needed.
- Do not move an injured person unless in a hazardous location.
- Cover people in SHOCK with blankets to keep them warm.

Check for Hazards

- Use fire extinguisher to extinguish small fires. Don't wait for the fire department. Evacuate buildings for larger fires.
- Leave the gas on unless you smell gas. Once off, only your utility company can turn it back on safely.
- Shut off power at the breaker box if you suspect electrical damage.
- UNPLUG APPLIANCES and electronic equipment. They could cause fires when power is restored.
- Beware of items tumbling off shelves when you open cabinet doors.
- Isolate or cover chemical spills with absorbent material such as dirt or cat litter.
- Stay away from BRICK CHIMNEYS and walls. Don't use fire place until inspected.

Step 7 RECONNECT AND RESTORE

IN THE DAYS AFTER THE EARTHQUAKE, FOLLOW YOUR PLAN

STAY AWAY FROM THE COAST UNTIL OFFICIALS DECLARE IT SAFE TO RETURN.

DISASTER SIGHTSEEING puts you in danger and hampers efforts of response personnel.

IF YOUR HOME isn't damaged, **STAY THERE.**

Sheltering in place is the safest thing to do even if the power is out.

- Do not use matches, lighters, or candles.
- Never use a camp stove, gas lantern or heater, gas or charcoal grill, or gas generator indoors.

BE IN COMMUNICATION AND STAY INFORMED

- Use your portable or car radio to find a station that is on the air and providing updates and safety advisories.
- LET PEOPLE KNOW YOU ARE OK. TEXT your out-of-area contact to tell them where you are. Stay off your phone to keep the lines open for emergency communications.
- Check on your neighbors.

FOOD AND WATER

- If the power is off, use refrigerated and frozen foods first. Food in the freezer may last several days.
- Use your stored water for drinking. You can also drink from water heaters, melted ice cubes, or canned vegetables. Don't drink water from swimming pools or hot tubs.

DOCUMENT DAMAGE.

Use your phone or camera to photograph anything you suspect may have been damaged. Contact your insurance agent right away to begin your claims process.

IF YOU CANNOT STAY IN YOUR HOME

- Use your radio to find shelter locations.
- Bring your Grab and Go Bag with medications and personal information. Shelter space is limited. Check to find out what you can bring, including pets.

THE FIRST WEEKS AFTER THE EARTHQUAKE

The earthquake and aftershocks take an emotional toll. Short tempers, memory lapses, and difficulty sleeping are common.

- If you aren't sure if your home is safe, contact the city or county for an inspection.
- If you turned off gas, only your utility provider can turn it back on.
- Have a professional inspect your fireplace or wood burning stove before you use them. Damage is difficult to see and could cause a chimney fire or poisonous gas release.
- Locate and or replace critical documents that may have been misplaced, damaged, or destroyed.

RUMORS ARE RAMPANT IN THE AFTERMATH OF A DISASTER

VERIFY INFORMATION FROM A REPUTABLE SOURCE BEFORE PASSING IT ON

Typical American Red Cross shelter



Special Considerations



Children enjoy earthquake drills.



[Helping children deal with disasters](#)

Children

Earthquakes and tsunamis are traumatic for everyone and especially frightening for children. After an earthquake, a child may fear another earthquake, injuries, and being separated from family. If parents are upset or unwilling to talk about what happened, fears may be amplified.

Children may become emotional, have difficulty sleeping, nightmares, and or disruptive behavior for weeks or months afterwards. Allowing a child to share a room may alleviate fears. It is not unusual for issues to re-emerge later. If this happens, listen and acknowledge your child's concerns. Seek professional help if fears persist.

BEFORE THE EARTHQUAKE

- TALK with children about what could happen and review your plan with them. Let them ask questions.
- INVOLVE children in activities such as reducing hazards, putting together a Grab and Go Bag, and helping create an earthquake plan. Include an emergency plan and pictures of family in your child's backpack and Grab and Go Bag.
- ASK your children's school or daycare what is their emergency response plan and what actions they have taken to reduce hazards. Keep your emergency contact information up to date.
- PRACTICE family earthquake drills and how to evacuate if you live in a tsunami zone. Talk about how you will reunite if separated.



Practicing family evacuation teaches everyone how to get to safety and what to do in a real event.

AFTER THE EARTHQUAKE

- REUNITE your family and stay together.
- LIMIT media coverage of the disaster. Repeated exposure to disturbing images and sounds will increase children's fears and anxieties.
- LISTEN to your child, acknowledge their concerns, and respond to questions with simple explanations.
- ENCOURAGE children to talk or draw pictures about their experience and include them in cleanup and safety activities whenever possible.

Fragile, Elderly, and Disabled

- Assess special needs for you and your family and write them down. Include medications and special equipment such as ventilators, oxygen tanks, and power supply needs.
- Keep medications, copies of prescriptions, spare eyeglasses, and other special equipment in a place that can be easily reached. Include information on dosages and how to use equipment in emergency plans.
- Keep WHISTLES, flashlight, notebooks, and pencils in several locations.
- Include supplies for seeing eye, hearing, or companion dogs.

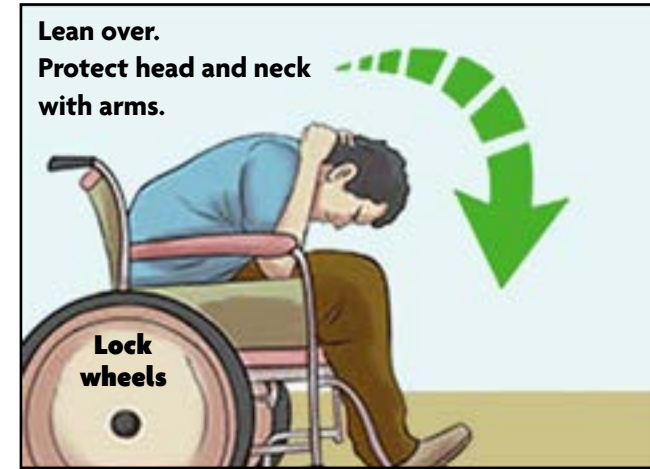

DURING AN EARTHQUAKE

- If you are in a wheelchair, lock the wheels once you are in a safe location.
- If unable to move safely and quickly, stay where you are, even in bed, and cover your head and body with your arms and pillows.

AFTER AN EARTHQUAKE

Use your whistle to call for help and signal others if you need it.



[Disaster tips for frail or disabled](#)

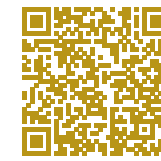

[Preparedness for livestock owners](#)



Pets and Livestock

- Include extra pet food, water, medications, and copies of rabies vaccinations in your emergency kits.
- Talk to neighbors about caring for your animals if you cannot get home.
- Consider getting your pet microchipped, a GPS tag, and have a pet photo to assist in reuniting if separated.
- Many emergency shelters don't allow pets. Prepare a list of people and locations that can shelter your pets in an emergency.

Emergency preparedness is particularly important for livestock because of food and shelter needs and challenges of transporting large and or numerous animals.

Make sure every animal has durable and visible identification.

- Identify alternate water and power sources. A generator with a safely-stored fuel supply may be essential to run equipment necessary to the well-being of your animals.



Going Further

Interested in doing more to prepare yourself, your home, and your community?

EARTHQUAKE INSURANCE

Your home may be your biggest asset. In seconds, shaking can damage both the structure and its contents. Consider purchasing earthquake insurance.

Most standard policies (homeowners, mobile homeowners, condominium, renters) **exclude** earthquake damage. All companies that sell residential insurance in California are required to offer earthquake insurance to homeowners at an additional premium.

Most residential property insurers in the State offer earthquake insurance through the California Earthquake Authority (CEA). Cost is based on a number of factors including earthquake hazard in your location, age of structure, construction type, and home value. Swimming pools, patios, and detached structures are excluded.

CEA policies provide:

- Home repair or replacement
- Additional living expenses for rental or temporary residence
- Replacement of personal property
- Emergency repairs
- Building code upgrades
- Land stabilization to adequately support home

All CEA policies have a deductible. You can opt for additional coverage to lower the deductible, increase personal property coverage, increase additional living expenses, and increase building code and land upgrades. CEA policies are offered only through the CEA's participating insurers.



[CEA earthquake insurance](#)

FLOOD INSURANCE

Homeowner policies don't cover flood damage from rivers, tsunami, or storm surge and cannot be purchased through residential insurance companies. Separate policies can be acquired through the National Flood Insurance Program. Flood insurance does not cover buildings that are entirely over water like boat houses or structures other than buildings.



[National Flood Insurance Program](#)

BECOME A CERT VOLUNTEER

COMMUNITY EMERGENCY RESPONSE TEAMS (CERT) are volunteers trained to respond in the minutes and hours after a disaster before professional responders reach your area. Certified by the Federal Emergency Management Agency (FEMA), CERT volunteers are usually recruited from a town or city to work together as a team. Training includes personal and community preparedness as well as learning to safely check on neighbors, provide first aid, control small fires, and give a preliminary situation assessment to the professionals when they arrive. CERT teams work closely with local government and fire, medical, and public safety officials.



[Humboldt CERT Coalition - training in Northern California](#)

WHAT HELP TO EXPECT FROM THE GOVERNMENT

Large earthquakes disrupt roads and communications, trigger numerous fires, and spread local resources very thin. Help will be coming but it may take days or even weeks to reach remote areas. The efforts you and your community take to prepare will help you through the initial period before outside help reaches you.

Government recovery assistance depends on the level of damage and the type of DISASTER DECLARATION in place.

DISASTER DECLARATIONS

1. Earthquake or other disaster occurs

2. Local government conducts a preliminary assessment – declares LOCAL EMERGENCY

3. Local government requests assistance from State – Governor may declare a STATE OF EMERGENCY

4. Governor requests assistance from federal government – President may declare a MAJOR DISASTER

Disaster declarations have nothing to do with the magnitude of an earthquake or the height of a tsunami. It is based only on estimated loss. State declarations reimburse local government for lost public structures such as roads and bridges and the costs of response. Only if the disaster makes it to the Federal level are individuals and businesses likely to receive financial assistance in the form of temporary housing and low interest loans. Don't expect the government to compensate you for your losses.

PREPAREDNESS ACTIONS TAKEN BEFORE A DISASTER ARE THE BEST WAY TO LIMIT LOSSES

CERT volunteer training



Copyright 2023, Humboldt Earthquake Education Center at Cal Poly Humboldt. Reproduction by permission only. *Disclaimer: This document promotes earthquake and tsunami readiness, based on the best currently available scientific, engineering, and sociological research; following its suggestions does not guarantee the safety of an individual or a structure. The writers, contributors, and sponsors of this handbook assume no liability for death, injuries, property damage, or other effects of an earthquake or tsunami.*

Prepared by the Humboldt Earthquake Education Center and the Redwood Coast Tsunami Work Group (RCTWG), in cooperation with the California Office of Emergency Services (Cal OES), Federal Emergency Management Agency (FEMA), California Geological Survey (CGS), California Earthquake Authority (CEA), Department of Interior United States Geological Survey (USGS), National Oceanographic and Atmospheric Administration (NOAA) National Weather Service, with contributions from many members of the Redwood Coast Tsunami Work Group. Much of the content is based on previous editions of *Living on Shaky Ground* (1993, 1996, 2008, 2011, 2016 by Dengler, Warren, Hemphill-Haley).

Writers: Lori Dengler and Vicki Ozaki (Cal Poly Humboldt)
Design: Amy Uyeki (Cal Poly Humboldt).
Web design: Cal Poly Humboldt MarCom, Amanda Admire (Cal Poly Humboldt).

Reviewers: Amanda Admire, Linda Nellist, Mark Hemphill-Haley (Cal Poly Humboldt), Troy Nicolini, Ryan Aylward (NOAA NWS), Jason Patton (CGS), Yvette LaDuke, Todd Becker (CalOES), Bob DeGroot (US Geological Survey), Quinn Ozaki-McNeill, Judy Warren, Patrick Lynch (Humboldt NCEMS), Andrew Michael (USGS).

Special thanks to the Southern California Earthquake Center for the *Seven Steps to Earthquake Safety*. Additional materials adapted from *Putting Down Roots in Earthquake Country*.

Illustrations and photographs: Amy Uyeki (cover, pgs. 3, 6, 18, 19, 22, 23, 24, 25, 26, 28, 32, and 33), Kellie Jo Brown (p. 4), Edna Garrett courtesy Peter Palmquist collection (pgs. 8, 11), Kevin Bayless (p. 8), Clark Museum (p. 10), Tom Lisle (p. 10); Ross Boulanger (p. 11), Anita Ho (p. 11), Smith Collection, Pacific Tsunami Museum (p. 12), AP Photo/Keichi Nakane, *The Yomiuri Shimbun* (p. 12), *Reuters* (p. 12), *Photoduck* (p. 12), Victor Kaistrenko (p. 16), USGS (pgs. 9, 29), Lori Dengler (pgs. 16, 27, 30), NOAA PMEL (p. 16), Bryant Anderson (p. 17), NASA (p. 17), Ann Elliot Cutting (p. 26), American Red Cross (p. 31), Linda Nellist (p. 34).

Printed by Bug Press, Arcata, California.

The Most Important Things To Remember About Earthquakes and Tsunamis



Don't move during shaking. Stay where you are. **DROP** to the ground, **COVER** your neck and head with your arms, and if under a table, **HOLD ON.**

In a tsunami zone? Shaking is your warning that a tsunami may arrive in minutes. Head to high ground or inland as soon as it is safe to walk. **When in Doubt, Drill it Out.**

Stay away from the coast until officials allow you to return. Dangerous surges could last for more than a day.

C O N T E N T S

Introduction

You Can Prepare	2
Answer These Questions Before a Disaster ...	4

Earthquakes

You Live in Earthquake Country	6
Notable Earthquakes.....	8
Types of Earthquakes.....	9
Earthquake Damage.....	10

Tsunamis

What is a Tsunami?.....	12
Two Ways to Know if a Tsunami is Coming...	14
Lessons from Recent Tsunamis	16

Earthquake Basics.....	18
Earthquake and Tsunami Misconceptions ...	19

Seven Steps That May Save Your Life

Introduction to the Seven Steps.....	20
--------------------------------------	----

Prepare

Step 1: Know Your Zone – Secure Your Space	22
Step 2: Plan to be Safe.....	24
Step 3: Organize Disaster Supplies.....	25
Step 4: Minimize Financial Hardship	26

Survive

Step 5: What to Do When the Ground Shakes	28
ShakeAlert	29
Step 6: When the Shaking Stops.....	30

Recover

Step 7: Reconnect and Restore	31
Special Considerations	
Children, Fragile, Elderly, Disabled	32
Pets and Livestock.....	33
Going further: Insurance, CERT	34
Disaster Declarations.....	35
Credits.....	35

Call the Humboldt Earthquake Hotline for a daily recording of earthquake activity locally and around the globe: (707) 826-6020. Follow the Redwood Coast Tsunami Work Group on Facebook: www.facebook.com/rctwg